

Hybrid Pro™ Modular Kit 08

HPM-1010-08

Hybrid Pro™ Modular exhibits and counters are a perfect solution for the serious exhibitor. Exhibits feature heavy-duty aluminum extrusion frames and push-fit fabric graphics. Count on making an unforgettable impact with Hybrid Pro Modular exhibit kits, counters, and accessories.



We are continually improving and modifying our product range and reserve the right to vary the specifications without prior notice. All dimensions and weights quoted are approximate and we accept no responsibility for variance. E&OE. See Graphic Templates for graphic bleed specifications.

features and benefits:

- Silver aluminum extrusion frame
- Slot wall
- Single-sided SEG dye-sublimated push-fit fabric graphics
- UV graphic on 6mm white printed Sintra infills
- Kit includes frame, slot wall, one fabric graphic panel, eight white Sintra infills, one counter, one medium monitor mount, one 200 LED floodlight, and two WMC-12X6 and one MCW43 molded cases
- Lifetime hardware warranty against manufacturer defects

dimensions:

Hardware

Assembled unit:
114.13" w x 94.5" h x 19.63" d
2899mm(w) x 2400mm(h) x 499mm(d)

Backwall Counter:
25.5" w x 39.2" h x 15.1" d approx.
648mm(w) x 996mm(h) x 384mm(d)

Counter holds max weight 50 lbs / 22.68 kgs

Shipping

Shipping dimensions - ships in 3 cases:
2 WMC-12X6 cases (each case): 52" l x 29" w x 15" h
1321mm(l) x 737mm(h) x 381mm(d)

1 MCW43 case: 49" l x 39" h x 15" d
1245mm(l) x 991mm(h) x 381mm(d)

Approximate shipping weight (entire kit):
300 lbs / 136 kgs

Graphic

Refer to related graphic templates for more information



additional information:

Graphic material: Dye-sublimated fabric and UV printed on 6mm white Sintra

Tabletop color options:



Lights Included: Lumina 200 LED floodlight, straight arm and adjustable head, black finish, 19.5" from end to end

Medium monitor bracket holds 26-40" LCD, maximum weight: 50 lbs / 22.68 kgs

R-HP-K-08

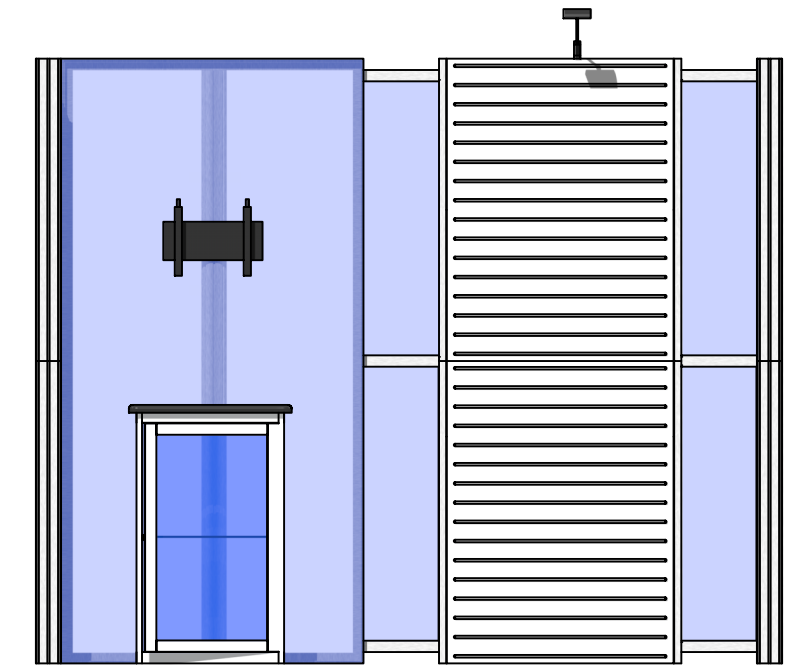
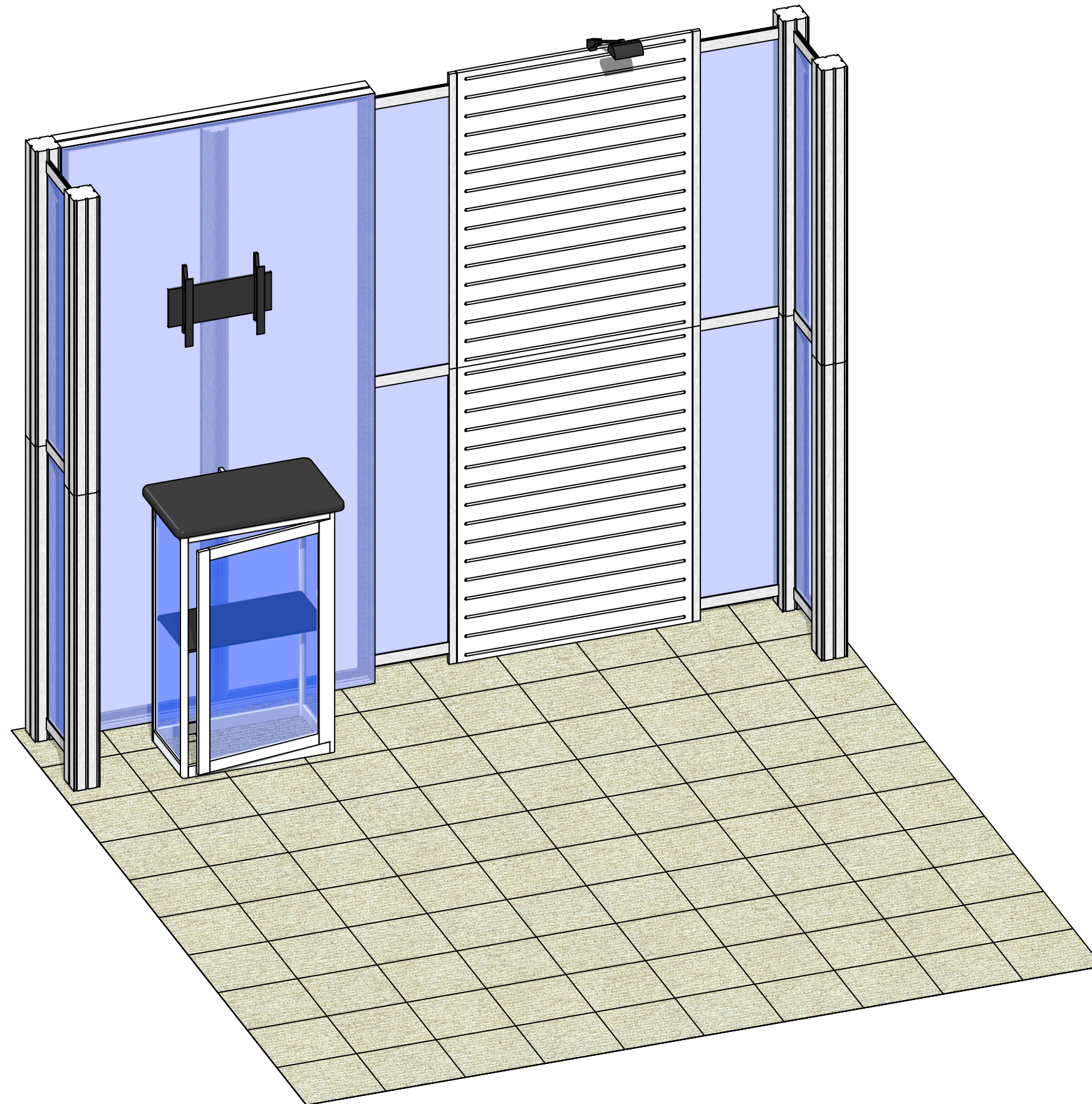

Code	#	Description
R11	2	1200MM (47.24") PHFC4 EXTRUSION WITH MITRE CUT 1 END FOR CB9 ONE END-IB2 HOLES ONE END - SIDE C
IB2	2	PH INLINE CONNECTOR
CB9	4	CB9 CORNER BRACKET
R9	2	1200MM (47.24") PHFC4 EXTRUSION WITH MITRE CUT BOTH ENDS
R10	2	1200MM (47.24") PHFC4 EXTRUSION WITH MITRE CUT 1 END FOR CB9 ONE END-IB2 HOLES ONE END
MM-MB	1	MEDIUM MONITOR BRACKET FOR MONITORS 15"-40"
GRAPHIC A	1	94 1/2" (H) X 47 1/4" (W) SINGLE SIDED DYESUB GRAPHIC W/ FCE-2 (SEG) ON PERIMETER
R15	8	1200MM (47.24") 100MM PM4S2 SQUARE EXTRUSION WITH PH2 STOP AT 305MM BOTH ENDS
LEDL10S	1	LED SPOTLIGHT,3M,UL PLUG W/TRANSFORMER SILVER
R8	12	300MM (11.81") PH EXTRUSION WITH LOCKS 2 ENDS
R12	2	1155MM (45.47") 100MM PM4R8 ROUND EXTRUSION WITH PH2 STOP AT 165MM AND 1 LOCK OTHER END
R14	1	300MM (11.81") PM4D CONNECTOR WITH TENSION GLIDES
R47	2	1200MM x 900MM LAMINATE SLOTWALL PANEL
GRAPHIC B6	1	12 1/4" (H) X 43 1/4" (W) DSG GRAPHIC ON 6MM WHITE SINTRA
GRAPHIC B5	1	12 1/4" (H) X 43 1/4" (W) DSG GRAPHIC ON 6MM WHITE SINTRA
GRAPHIC B8	1	12 1/4" (H) X 43 1/4" (W) DSG GRAPHIC ON 6MM WHITE SINTRA
GRAPHIC B7	1	12 1/4" (H) X 43 1/4" (W) DSG GRAPHIC ON 6MM WHITE SINTRA
GRAPHIC B4	1	12 1/4" (H) X 43 1/4" (W) DSG GRAPHIC ON 6MM WHITE SINTRA
GRAPHIC B3	1	12 1/4" (H) X 43 1/4" (W) DSG GRAPHIC ON 6MM WHITE SINTRA
GRAPHIC B2	1	12 1/4" (H) X 43 1/4" (W) DSG GRAPHIC ON 6MM WHITE SINTRA
GRAPHIC B1	1	12 1/4" (H) X 43 1/4" (W) DSG GRAPHIC ON 6MM WHITE SINTRA
R13	4	600MM (23.62") PM4D CONNECTOR WITH TENSION GLIDES
P180-1200	4	1200MM (47.24") P180 EXTRUSION
L180N-900	4	900MM (35.43") 180N DEGREE SILVER LINK EXTRUSION
L180N-600	2	600MM (23.62") 180N DEGREE SILVER LINK EXTRUSION
INT SHELF	1	292MM X 553 (11 1/2" X 21 3/4") INTERNAL SHELF FOR V-CU-CAB-01
R50	4	280MM (11") PH WITH SLIDE LOCK AT BOTH ENDS
GRAPHIC E1	1	922MM X 292MM (36 5/16" X 11 1/2") SIDE SINTRA/FOAMEX
GRAPHIC E2	1	922MM X 292MM (36 5/16" X 11 1/2") SIDE SINTRA/FOAMEX
R53	1	581MM X 1000MM (22 7/8" X 39 3/8") FRONT FRAME W/GFX INFILL
R52	1	581MM X 1000MM (22 7/8" X 39 3/8") CABINET DOOR W/GFX INFILL
V-SS1	4	SHELF SUPPORT
V-CW-CT-01	1	384MM X 646MM (15 1/8" X 25 7/16") HYBRID RECTANGLE TOP
R48	1	100MM (3.94") PH1 EXTRUSION WITH LOCKS 2 ENDS

BOM

R-HP-K-08

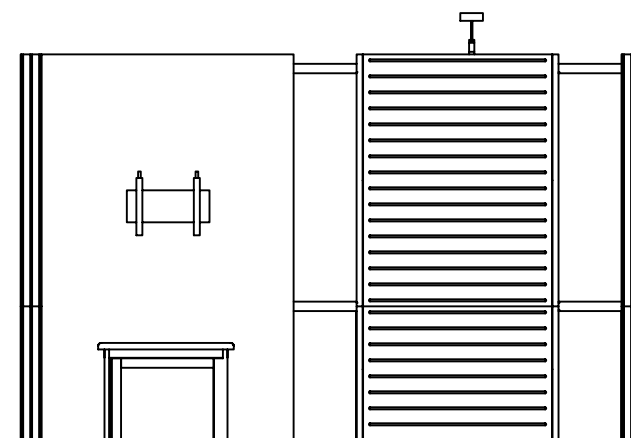
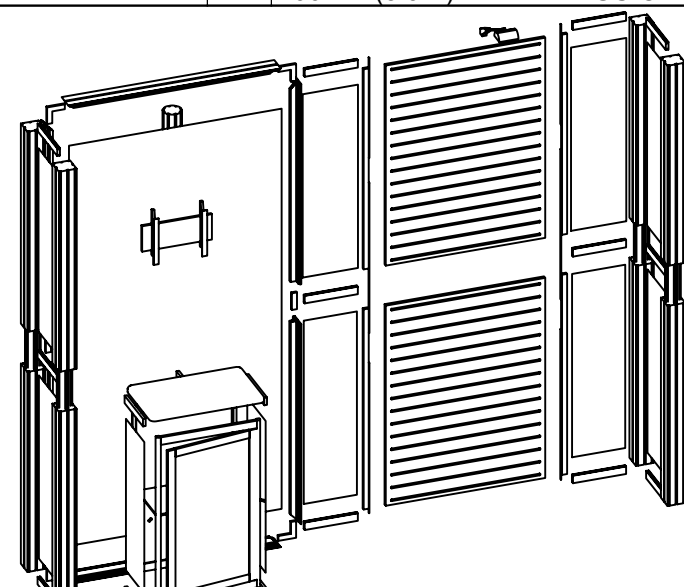
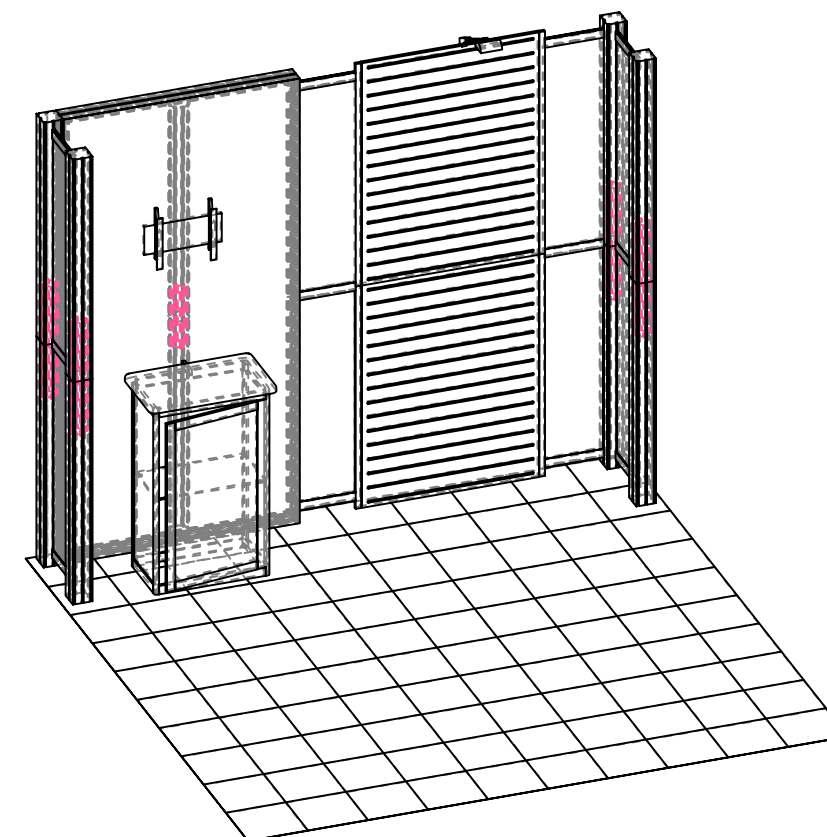
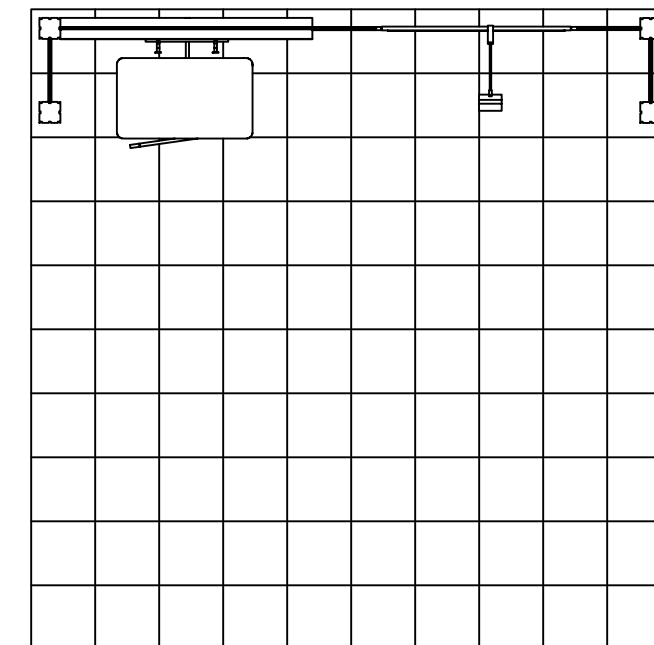

1. Redesign of this exhibit without approval by manufacturer may result in dangerous and unsafe structures. Manufacturer disclaims any responsibility for redesigned exhibits it does not approve in writing.

2. Parts and components such as panels and extrusions are manufactured to metric sizing. Where ever possible sizes have been noted in feet and inches as well as in metric. Below is the imperial to metric sizing table as reference. "Nominal" refers to approximate size.

- | | |
|--------------------|-----------------------------------|
| 2400mm = (94 1/2") | ▼ Phone Line / Fax |
| 2100mm = (82 5/8") | ▼ Internet connection |
| 1800mm = (70 7/8") | ▼ Outlet |
| 1500mm = (59") | ▼ Main Drop (point of distrution) |
| 1200mm = (47 1/4") | |
| 900mm = (35 1/2") | |
| 600mm = (23 5/8") | |
| 300mm = (11 7/8") | |
- Wire running under carpet

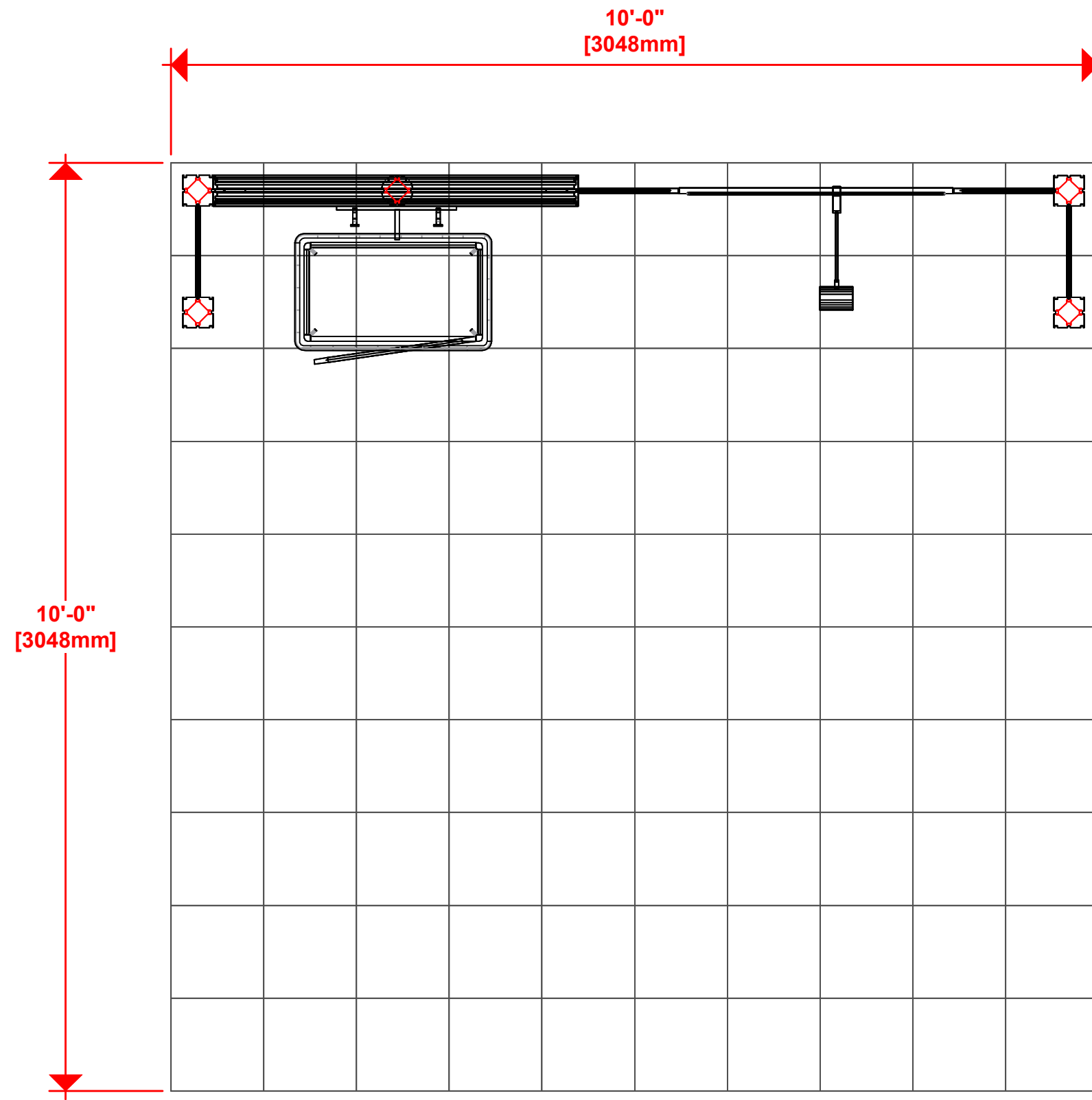

(1) LEDL 10S LIGHTS = 50W PER STICK

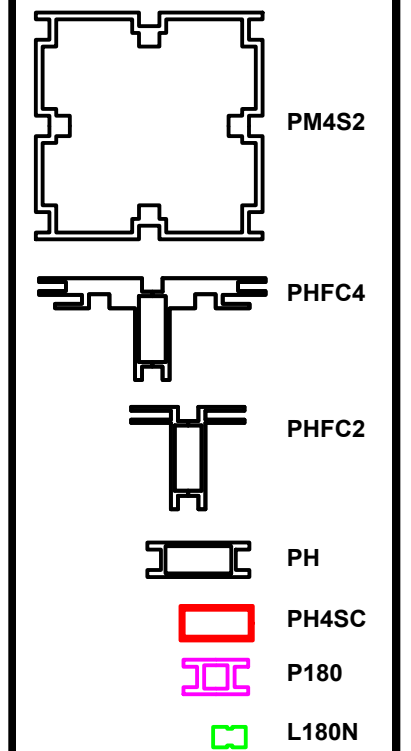

HYBRID PRO RENTAL KIT

Title: SET-UP INSTRUCTIONS

EP

Code	#	Description
R11	2	1200MM (47.24") PHFC4 EXTRUSION WITH MITRE CUT 1 END FOR CB9 ONE END-IB2 HOLES ONE
IB2	2	PH INLINE CONNECTOR
CB9	4	CB9 CORNER BRACKET
R9	2	1200MM (47.24") PHFC4 EXTRUSION WITH MITRE CUT BOTH ENDS
R10	2	1200MM (47.24") PHFC4 EXTRUSION WITH MITRE CUT 1 END FOR CB9 ONE END-IB2 HOLES ONE
R12	2	1155MM (45.47") 100MM PM4R8 ROUND EXTRUSION WITH PH2 STOP AT 165MM AND 1 LOCK OT
R14	1	300MM (11.81") PM4D CONNECTOR WITH TENSION GLIDES

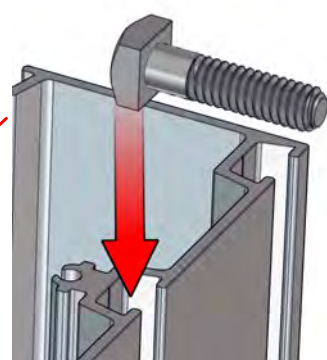
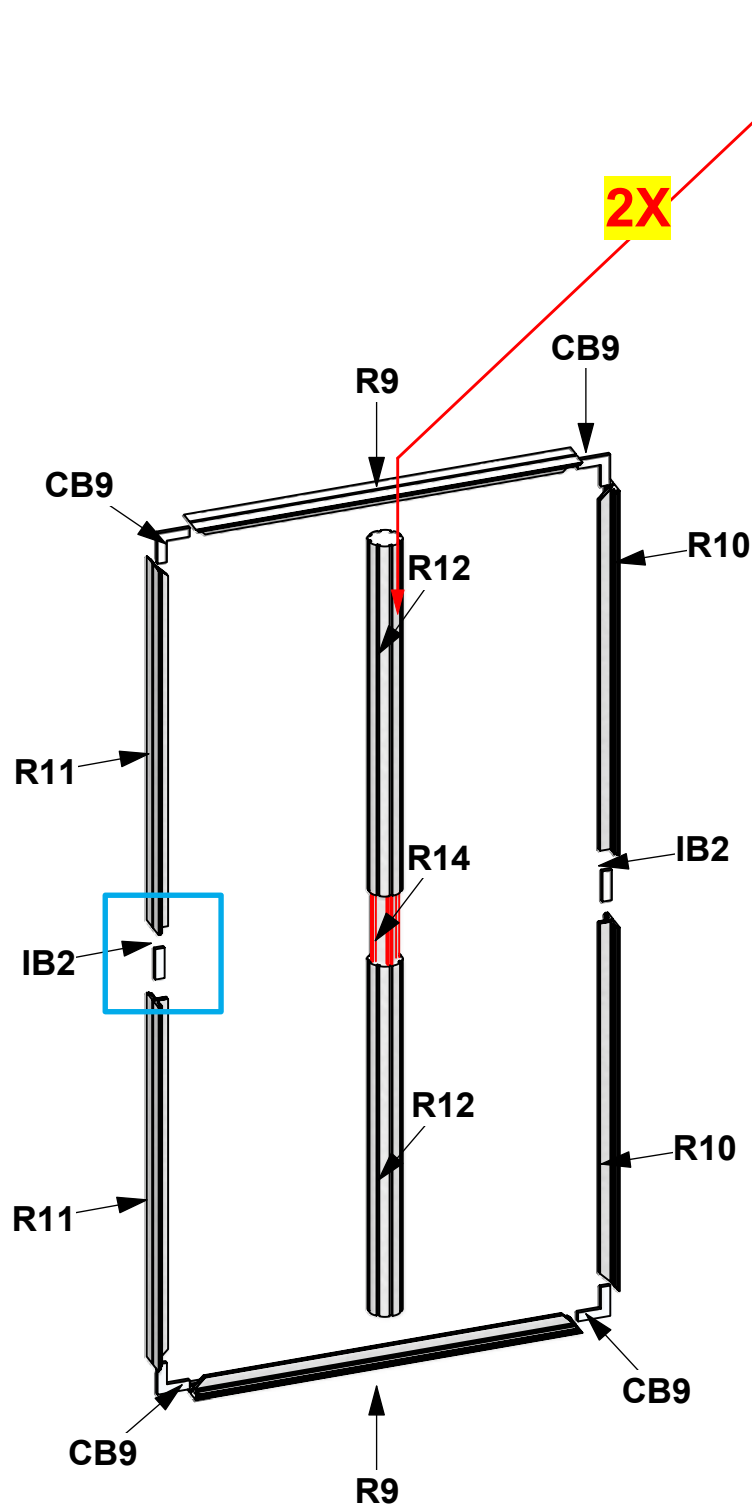

SLIDE SQUARE HEAD BOLTS INTO MIDDLE CHANNEL

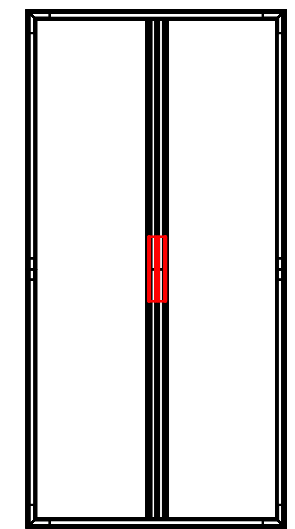
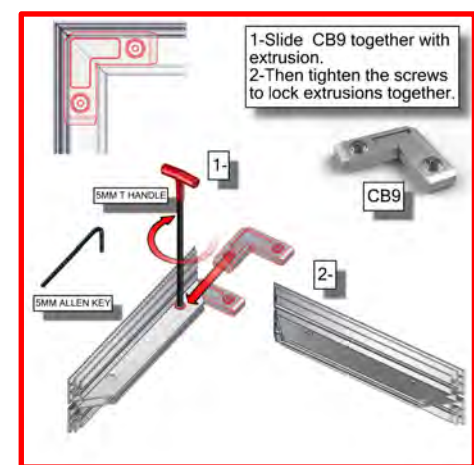
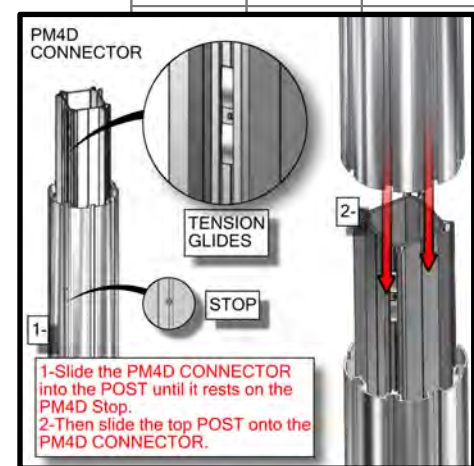

1. Redesign of this exhibit without approval by manufacturer may result in dangerous and unsafe structures. Manufacturer disclaims any responsibility for redesigned exhibits it does not approve in writing.

2. Parts and components such as panels and extrusions are manufactured to metric sizing. Where ever possible sizes have been noted in feet and inches as well as in metric. Below is the imperial to metric sizing table as reference. "Nominal" refers to approximate size.

2400mm = (94 1/2")	Phone Line / Fax
2100mm = (82 5/8")	Internet connection
1800mm = (70 7/8")	Outlet
1500mm = (59")	Main Drop (point of distrution)
1200mm = (47 1/4")	
900mm = (35 1/2")	
600mm = (23 5/8")	
300mm = (11 7/8")	

--- Wire running under carpet

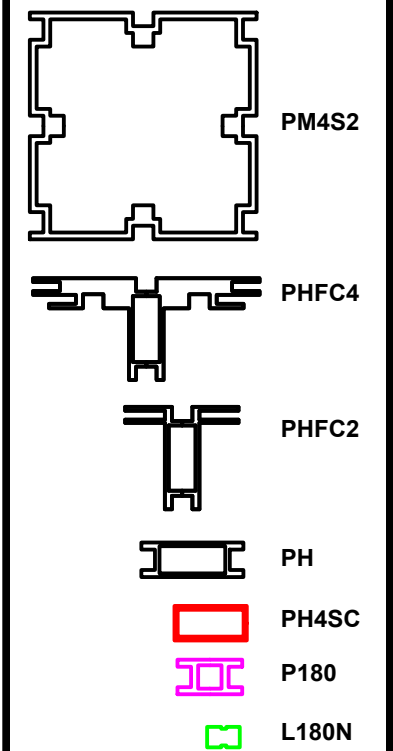

HYBRID PRO RENTAL KIT

Title: SET-UP INSTRUCTIONS

Code	#	Description
R15	4	1200MM (47.24") 100MM PM4S2 SQUARE EXTRUSION WITH PH2 STOP A
R8	4	300MM (11.81") PH EXTRUSION WITH LOCKS 2 ENDS
R47	1	1200MM x 900MM LAMINATE SLOTWALL PANEL
P180-1200	2	1200MM (47.24") P180 EXTRUSION
L180N-900	2	900MM (35.43") 180N DEGREE SILVER LINK EXTRUSION

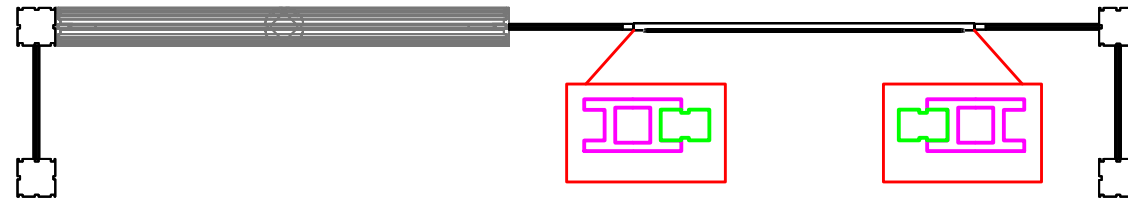

IMPORTANT!
PLACE PH AND INFILL (SEE NEXT PAGE) \ON THE SEAM,
THEN LOCK BOTTOM PH AT
THE CORRECT HEIGHT FROM
THE FLOOR

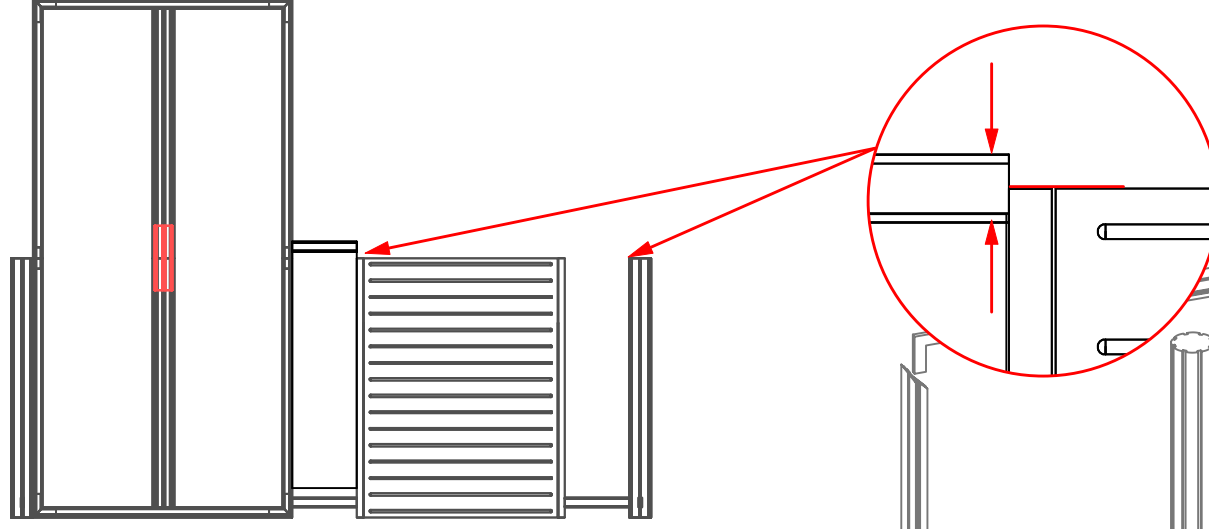

WARNING!
 Locks should **ONLY**
 be turned a quarter turn, so
 as not to **STRIP** the locks by
 over torquing them

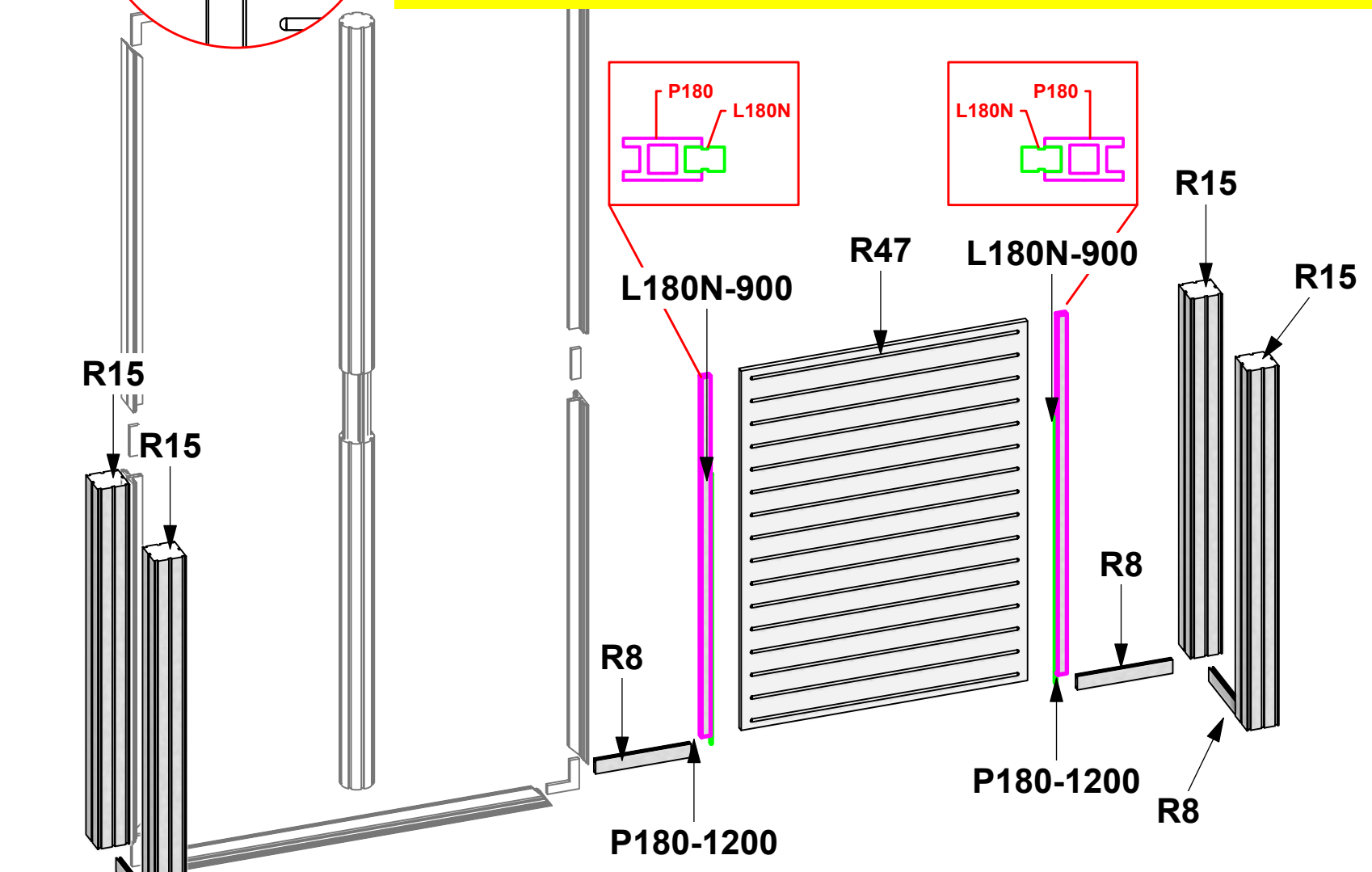
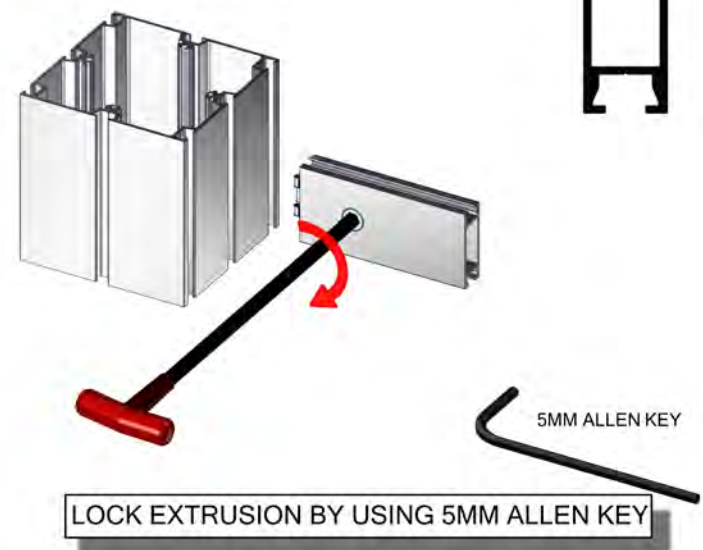

1. Redesign of this exhibit without approval by manufacturer may result in dangerous and unsafe structures. Manufacturer disclaims any responsibility for redesigned exhibits it does not approve in writing.

2. Parts and components such as panels and extrusions are manufactured to metric sizing. Where ever possible sizes have been noted in feet and inches as well as in metric. Below is the imperial to metric sizing table as reference. *Nominal* refers to approximate size.

2400mm = (94 1/2")	☎ Phone Line / Fax
2100mm = (82 5/8")	🌐 Internet connection
1800mm = (70 7/8")	🔌 Outlet
1500mm = (59")	⚡ Main Drop (point of distrution)
1200mm = (47 1/4")	
900mm = (35 1/2")	
600mm = (23 5/8")	
300mm = (11 7/8")	

--- Wire running under carpet ---

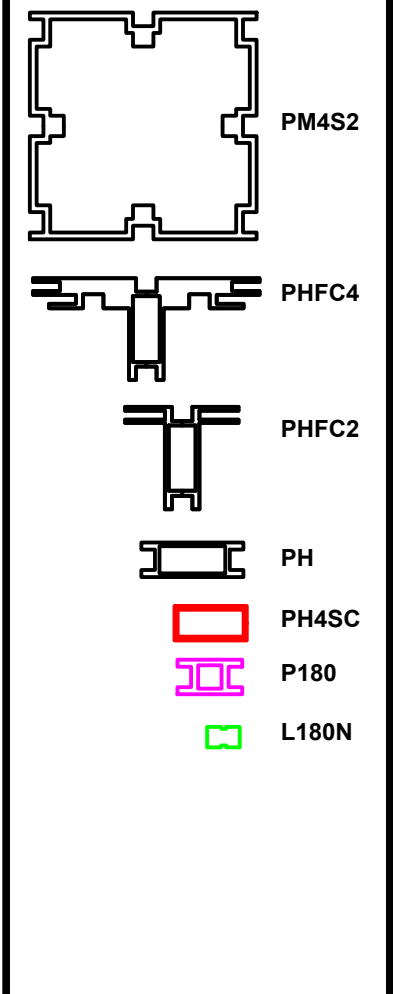

HYBRID PRO RENTAL KIT

Title: SET-UP INSTRUCTIONS

Code	#	Description
R8	4	300MM (11.81") PH EXTRUSION WITH LOCKS 2 ENDS
GRAPHIC B6	1	12 1/4" (H) X 43 1/4" (W) DSG GRAPHIC ON 6MM WHITE SINTRA
GRAPHIC B8	1	12 1/4" (H) X 43 1/4" (W) DSG GRAPHIC ON 6MM WHITE SINTRA
GRAPHIC B4	1	12 1/4" (H) X 43 1/4" (W) DSG GRAPHIC ON 6MM WHITE SINTRA
GRAPHIC B2	1	12 1/4" (H) X 43 1/4" (W) DSG GRAPHIC ON 6MM WHITE SINTRA

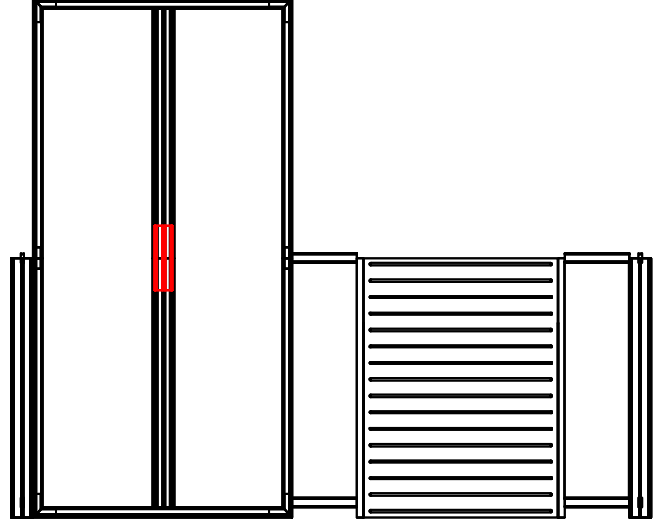
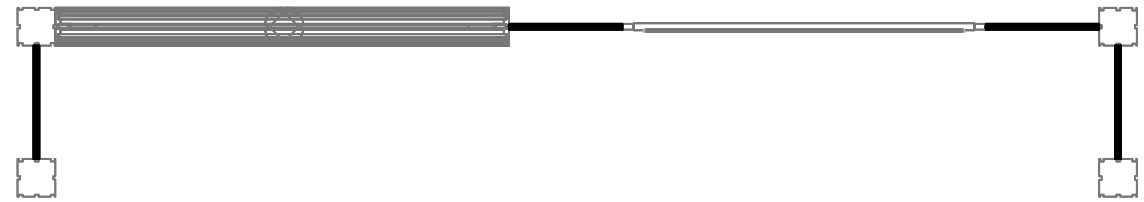

WARNING!
Locks should ONLY be turned a quarter turn, so as not to STRIP the locks by over torquing them

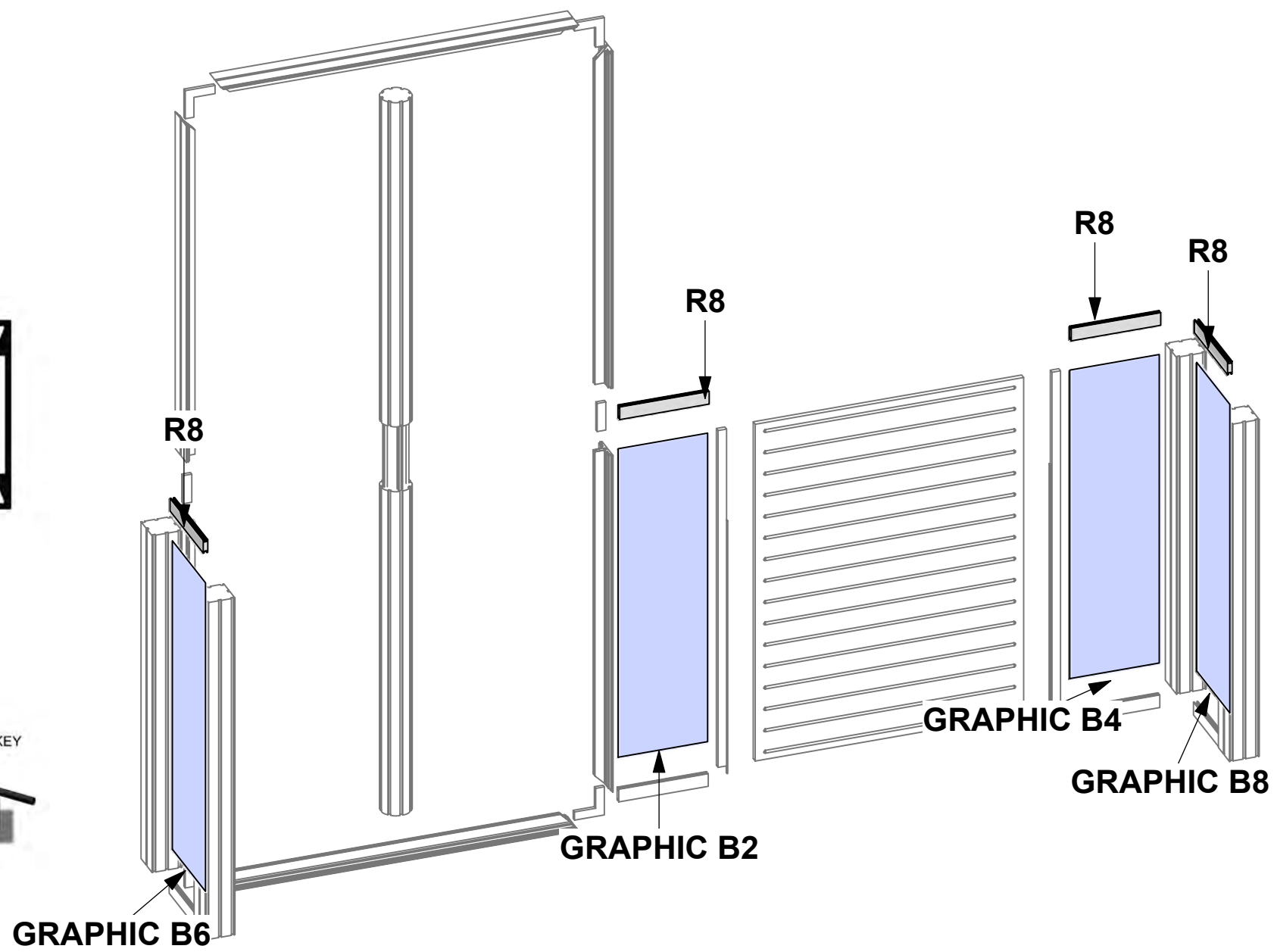
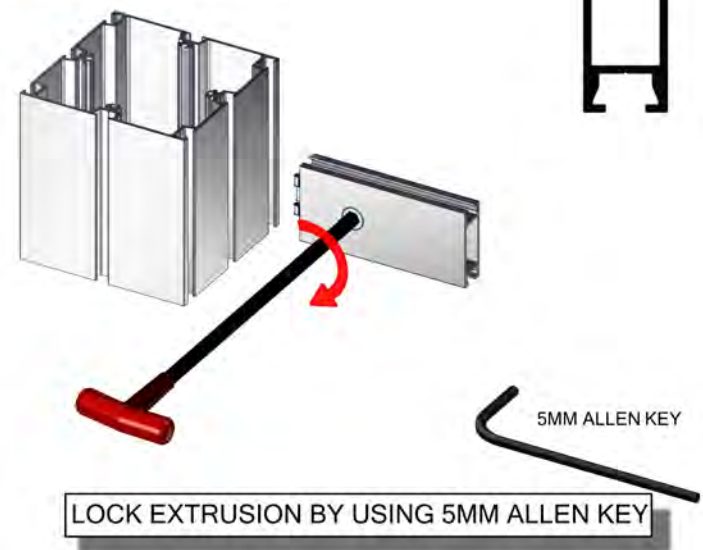

1. Redesign of this exhibit without approval by manufacturer may result in dangerous and unsafe structures. Manufacturer disclaims any responsibility for redesigned exhibits it does not approve in writing.

2. Parts and components such as panels and extrusions are manufactured to metric sizing. Where ever possible sizes have been noted in feet and inches as well as in metric. Below is the imperial to metric sizing table as reference. "Nominal" refers to approximate size.

2400mm = (94 1/2")	Phone Line / Fax
2100mm = (82 5/8")	Internet connection
1800mm = (70 7/8")	Outlet
1500mm = (59")	Main Drop (point of distrution)
1200mm = (47 1/4")	
900mm = (35 1/2")	
600mm = (23 5/8")	
300mm = (11 7/8")	

--- Wire running under carpet

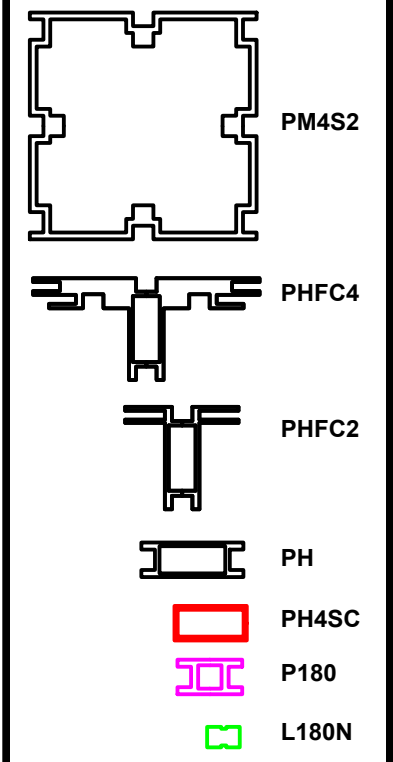

HYBRID PRO RENTAL KIT

Title: SET-UP INSTRUCTIONS

Code	#	Description
R15	4	1200MM (47.24") 100MM PM4S2 SQUARE EXTRUSION WITH P
R47	1	1200MM x 900MM LAMINATE SLOTWALL PANEL
R13	4	600MM (23.62") PM4D CONNECTOR WITH TENSION GLIDES
P180-1200	2	1200MM (47.24") P180 EXTRUSION
L180N-900	2	900MM (35.43") 180N DEGREE SILVER LINK EXTRUSION
L180N-600	2	600MM (23.62") 180N DEGREE SILVER LINK EXTRUSION

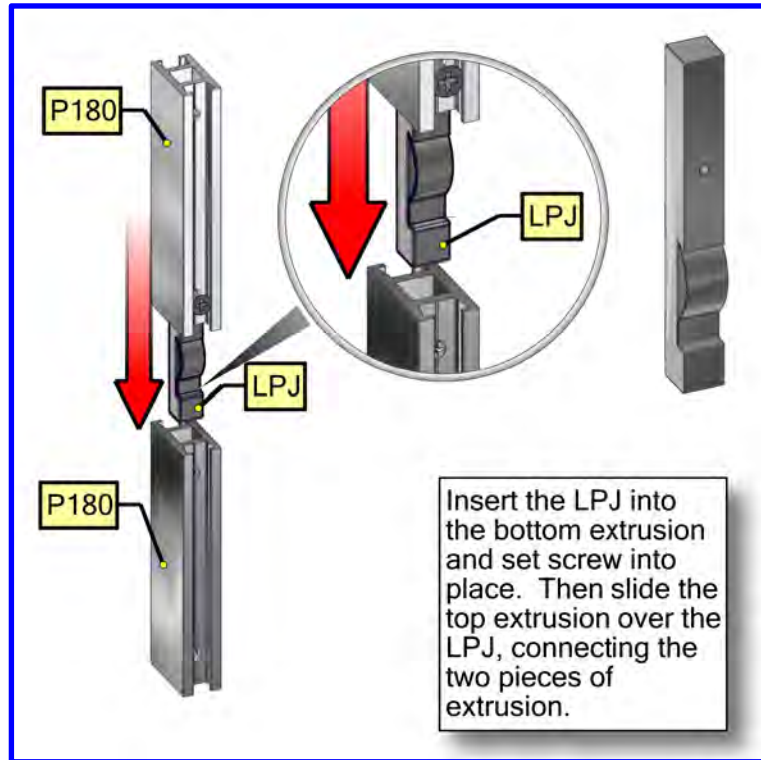

WARNING!
Locks should ONLY be turned a quarter turn, so as not to STRIP the locks by over torquing them

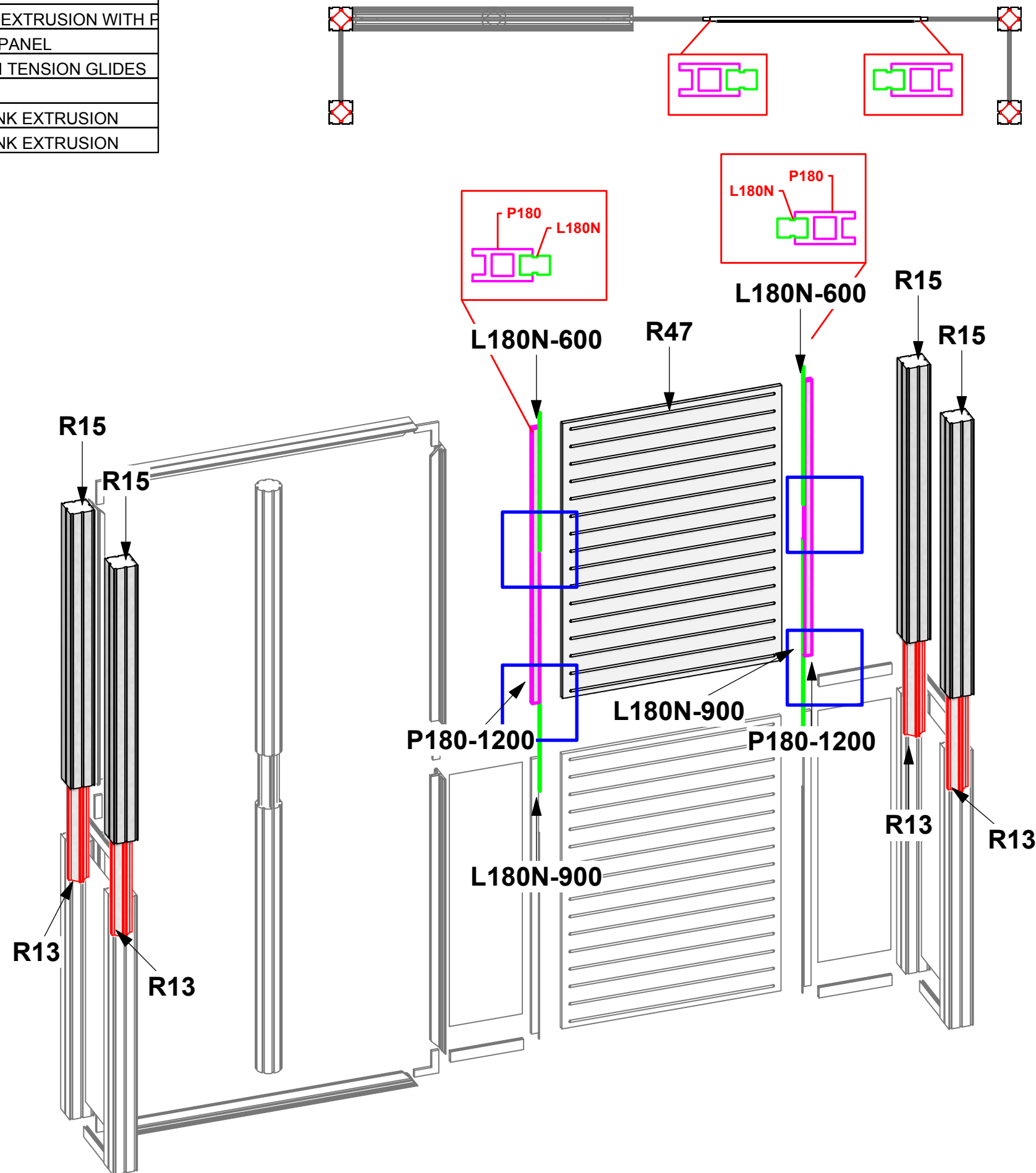
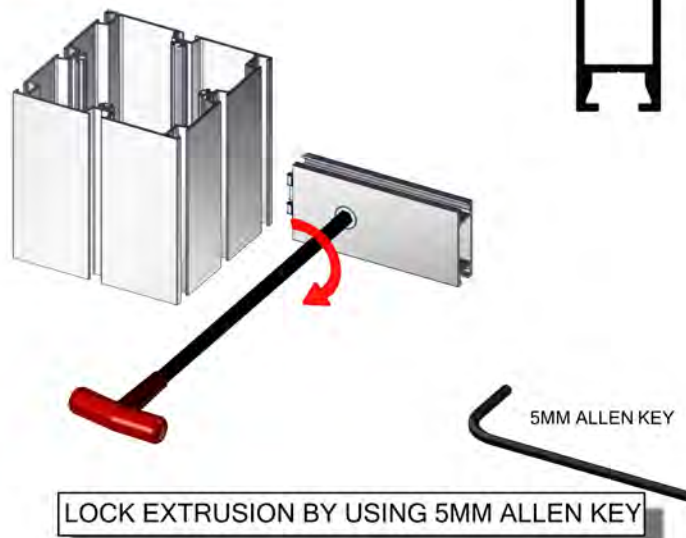

1. Redesign of this exhibit without approval by manufacturer may result in dangerous and unsafe structures. Manufacturer disclaims any responsibility for redesigned exhibits it does not approve in writing.

2. Parts and components such as panels and extrusions are manufactured to metric sizing. Where ever possible sizes have been noted in feet and inches as well as in metric. Below is the imperial to metric sizing table as reference. "Nominal" refers to approximate size.

2400mm = (94 1/2")	Phone Line / Fax
2100mm = (82 5/8")	Internet connection
1800mm = (70 7/8")	Outlet
1500mm = (59")	Main Drop (point of distrution)
1200mm = (47 1/4")	Wire running under carpet
900mm = (35 1/2")	
600mm = (23 5/8")	
300mm = (11 7/8")	

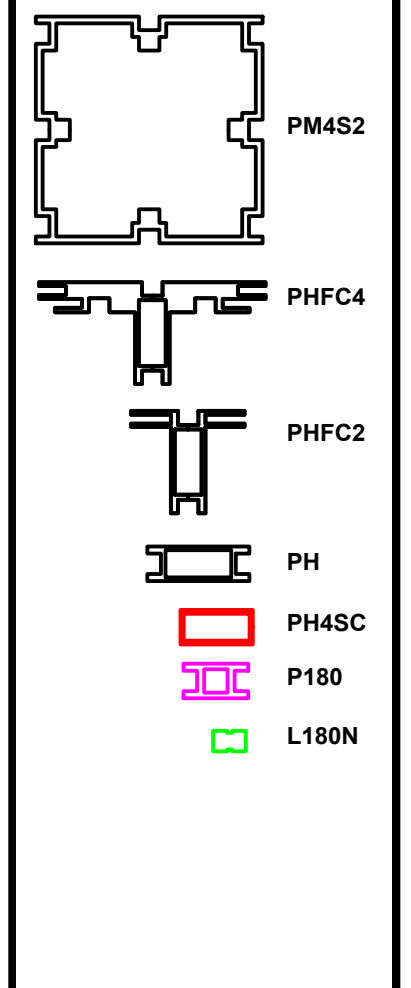

HYBRID PRO RENTAL KIT

Title: SET-UP INSTRUCTIONS

Code	#	Description
R8	4	300MM (11.81") PH EXTRUSION WITH LOCKS 2 ENDS
GRAPHIC B5	1	12 1/4" (H) X 43 1/4" (W) DSG GRAPHIC ON 6MM WHITE
GRAPHIC B7	1	12 1/4" (H) X 43 1/4" (W) DSG GRAPHIC ON 6MM WHITE
GRAPHIC B3	1	12 1/4" (H) X 43 1/4" (W) DSG GRAPHIC ON 6MM WHITE
GRAPHIC B1	1	12 1/4" (H) X 43 1/4" (W) DSG GRAPHIC ON 6MM WHITE

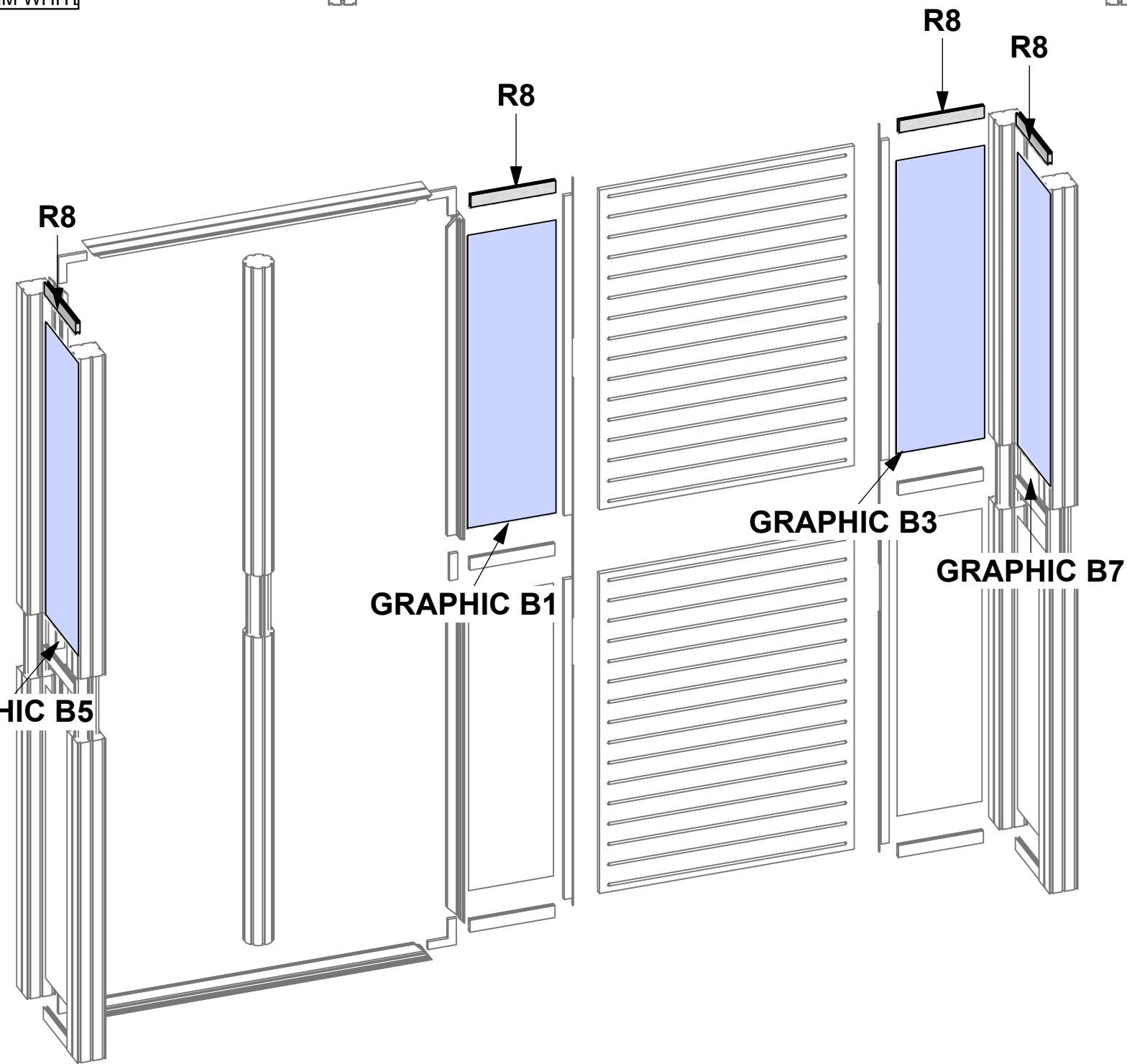
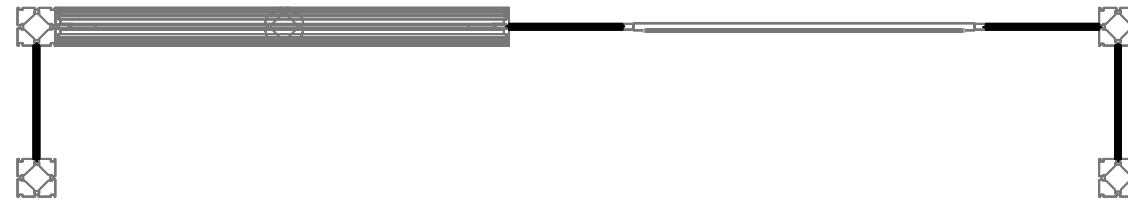

WARNING!
Locks should ONLY be turned a quarter turn, so as not to STRIP the locks by over torqueing them

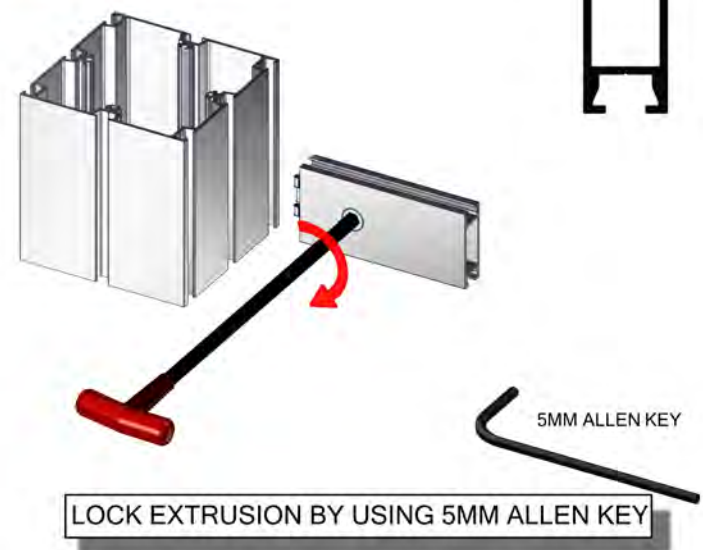

1. Redesign of this exhibit without approval by manufacturer may result in dangerous and unsafe structures. Manufacturer disclaims any responsibility for redesigned exhibits it does not approve in writing.

2. Parts and components such as panels and extrusions are manufactured to metric sizing. Where ever possible sizes have been noted in feet and inches as well as in metric. Below is the imperial to metric sizing table as reference. "Nominal" refers to approximate size.

2400mm = (94 1/2")	Phone Line / Fax
2100mm = (82 5/8")	Internet connection
1800mm = (70 7/8")	Outlet
1500mm = (59")	Main Drop (point of distrution)
1200mm = (47 1/4")	
900mm = (35 1/2")	
600mm = (23 5/8")	
300mm = (11 7/8")	

--- Wire running under carpet

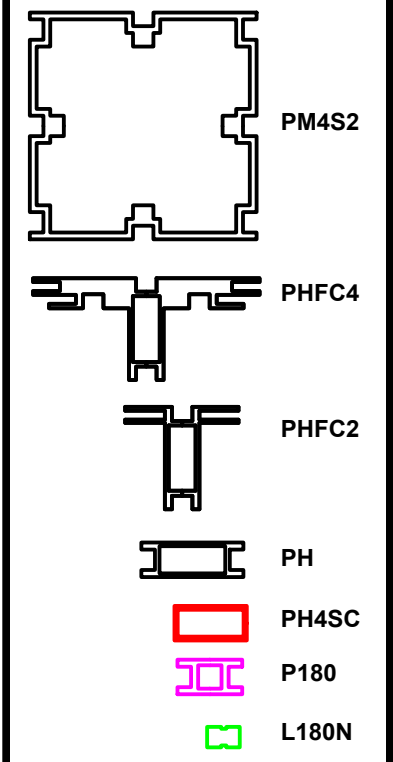

HYBRID PRO RENTAL KIT

Title: SET-UP INSTRUCTIONS

Code	#	Description
MM-MB	1	MEDIUM MONITOR BRACKET FOR MONITORS 15"-40"
GRAPHIC A	1	94 1/2" (H) X 47 1/4" (W) SINGLE SIDED DYESUB GRAPHIC W/ FCE-2 (SEG) O
LEDL10S	1	LED SPOTLIGHT,3M,UL PLUG W/TRANSFORMER SILVER
R48	1	100MM (3.94") PH1 EXTRUSION WITH LOCKS 2 ENDS

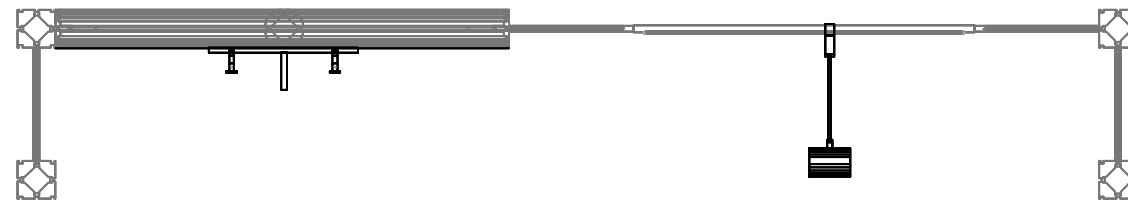

1. Redesign of this exhibit without approval by manufacturer may result in dangerous and unsafe structures. Manufacturer disclaims any responsibility for redesigned exhibits it does not approve in writing.

2. Parts and components such as panels and extrusions are manufactured to metric sizing. Where ever possible sizes have been noted in feet and inches as well as in metric. Below is the imperial to metric sizing table as reference. "Nominal" refers to approximate size.

2400mm = (94 1/2")	Phone Line / Fax
2100mm = (82 5/8")	Internet connection
1800mm = (70 7/8")	Outlet
1500mm = (59")	Main Drop (point of distrution)
1200mm = (47 1/4")	
900mm = (35 1/2")	
600mm = (23 5/8")	
300mm = (11 7/8")	

--- Wire running under carpet

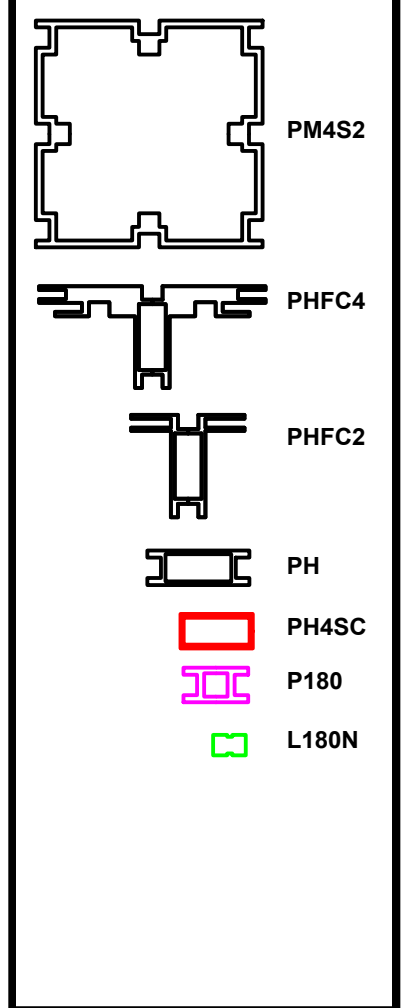
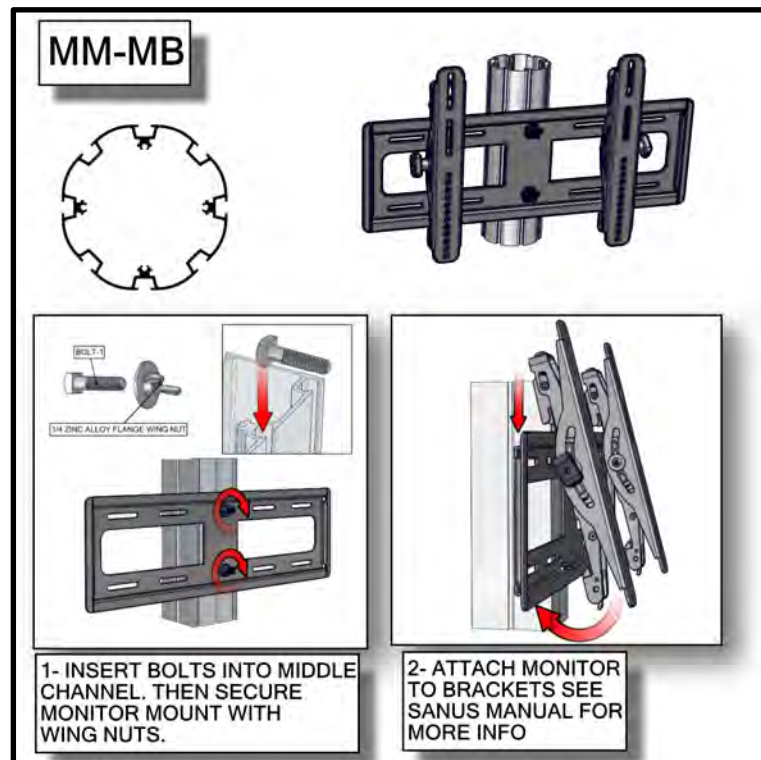
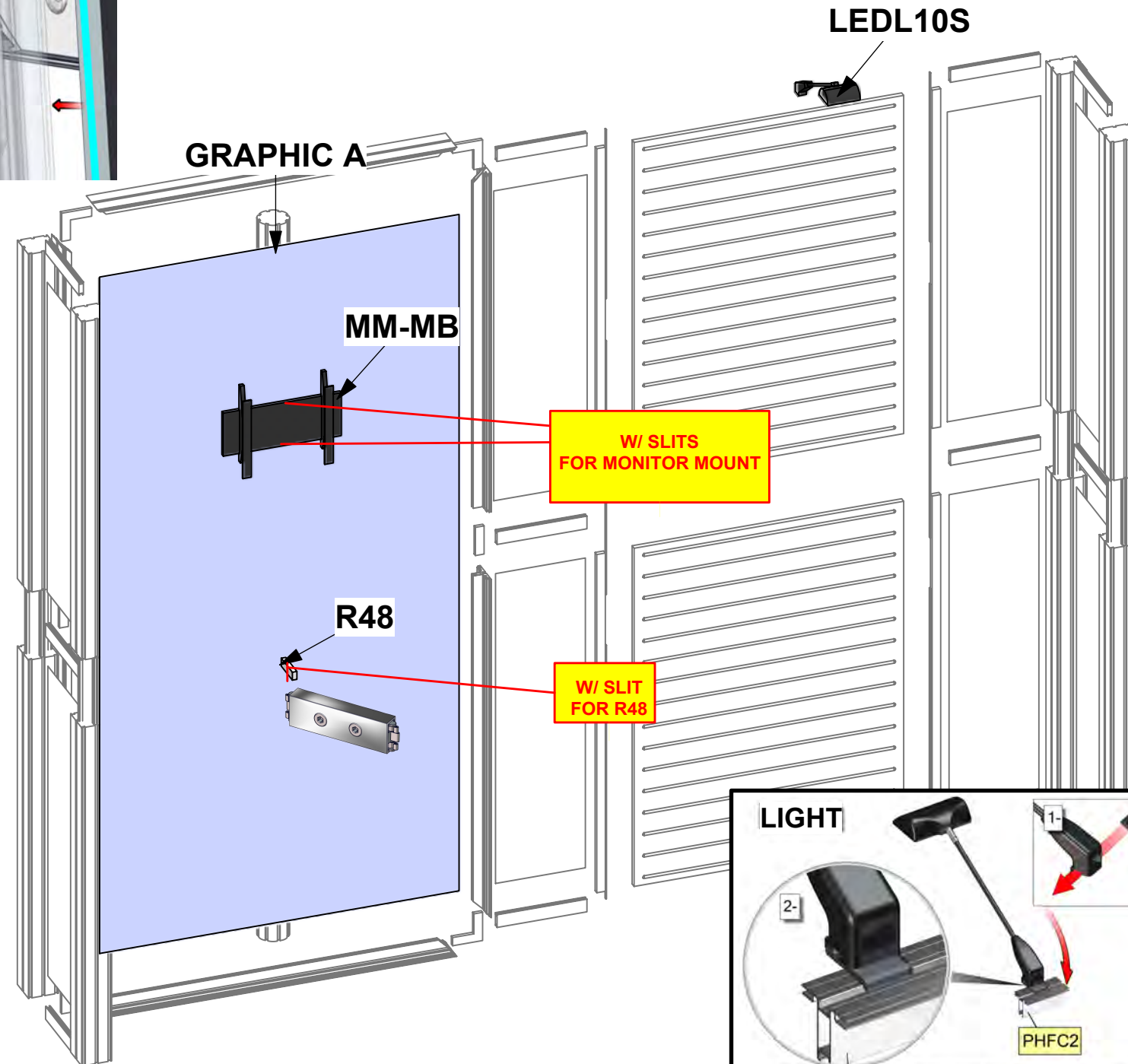
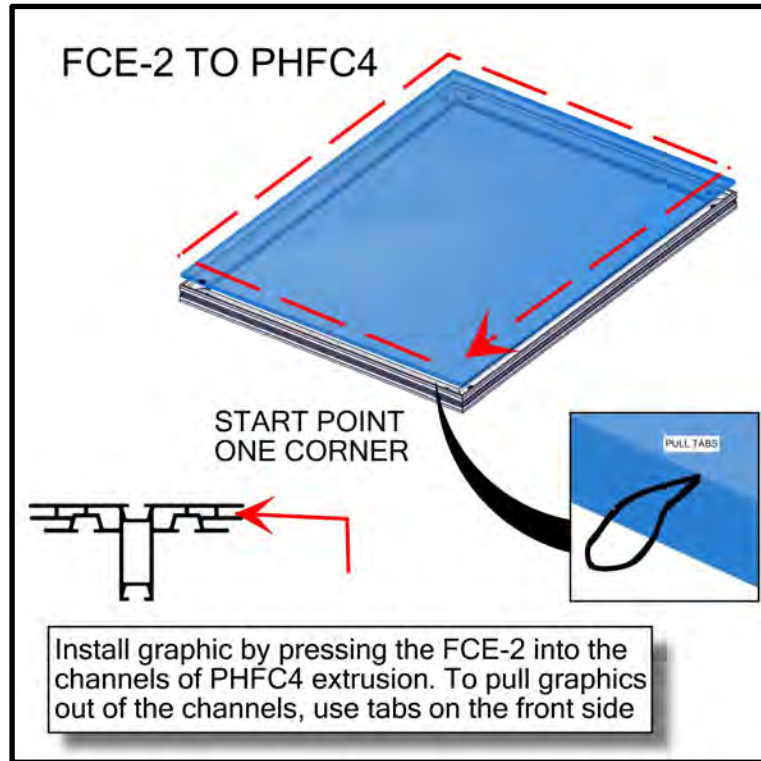

HYBRID PRO RENTAL KIT

Title: SET-UP INSTRUCTIONS

Code	#	Description
R50	2	280MM (11") PH WITH SLIDE LOCK AT BOTH ENDS
R53	1	581MM X 1000MM (22 7/8" X 39 3/8") FRONT FRAME W/GFX INFILL
R52	1	581MM X 1000MM (22 7/8" X 39 3/8") CABINET DOOR W/GFX INFILL

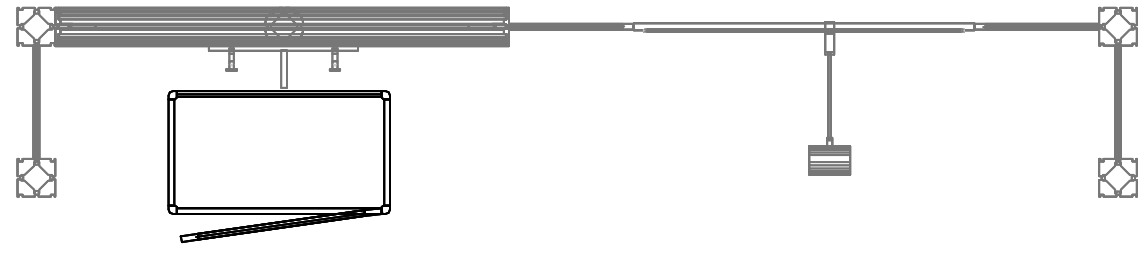

1. Redesign of this exhibit without approval by manufacturer may result in dangerous and unsafe structures. Manufacturer disclaims any responsibility for redesigned exhibits it does not approve in writing.

2. Parts and components such as panels and extrusions are manufactured to metric sizing. Where ever possible sizes have been noted in feet and inches as well as in metric. Below is the imperial to metric sizing table as reference. "Nominal" refers to approximate size.

- 2400mm = (94 1/2") Phone Line / Fax
 - 2100mm = (82 5/8") Internet connection
 - 1800mm = (70 7/8") Outlet
 - 1500mm = (59") Main Drop (point of distrution)
 - 1200mm = (47 1/4")
 - 900mm = (35 1/2")
 - 600mm = (23 5/8")
 - 300mm = (11 7/8")
- Wire running under carpet

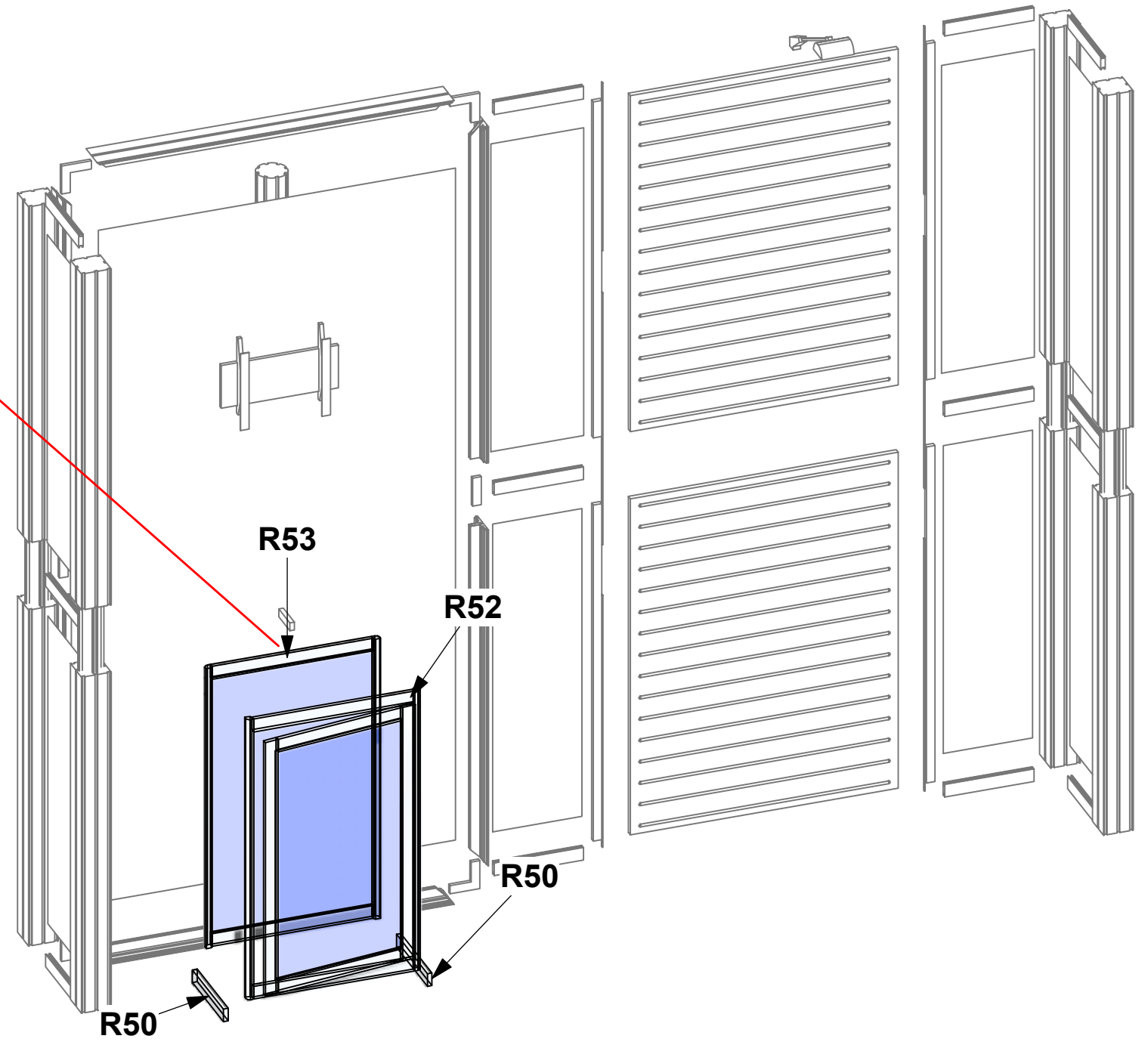
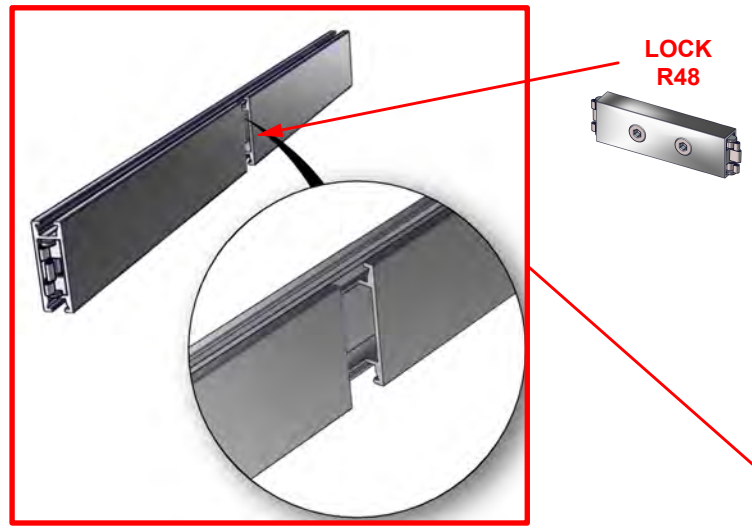

WARNING!
Locks should ONLY be turned a half (or quarter) turn so as not to STRIP the locks by over torquing them

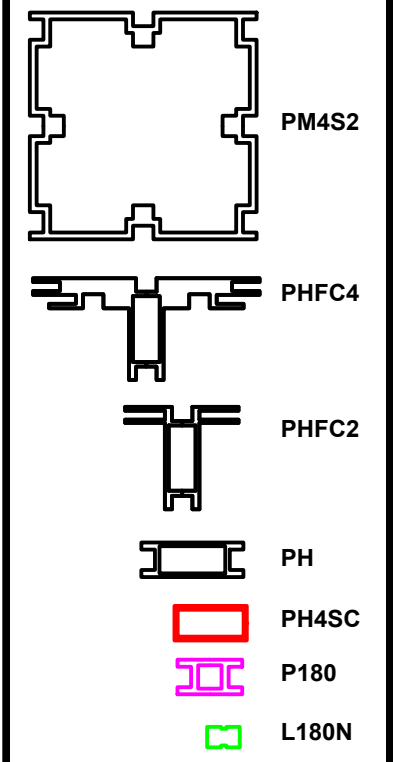
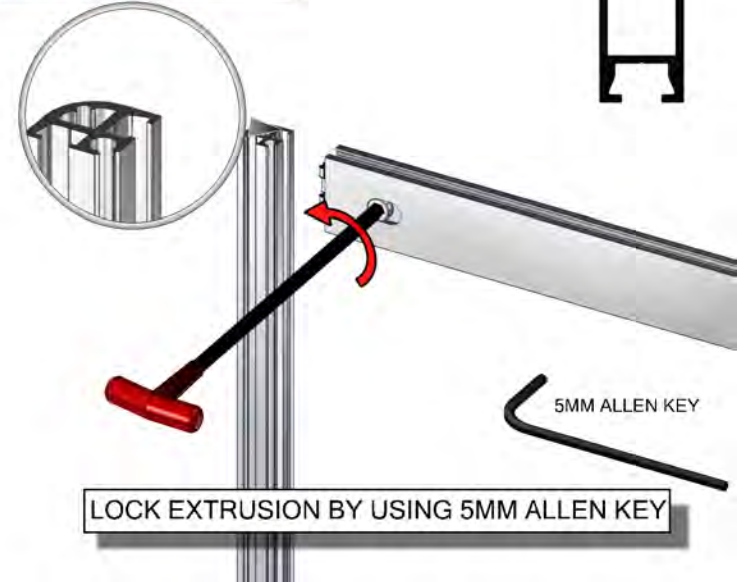

HYBRID PRO RENTAL KIT

Title: SET-UP INSTRUCTIONS

Code	#	Description
INT SHELF	1	292MM X 553 (11 1/2" X 21 3/4") INTERNAL SHELF FOR V-CU-CAB-01
R50	2	280MM (11") PH WITH SLIDE LOCK AT BOTH ENDS
GRAPHIC E1	1	922MM X 292MM (36 5/16" X 11 1/2") SIDE SINTRA/FOAMEX
GRAPHIC E2	1	922MM X 292MM (36 5/16" X 11 1/2") SIDE SINTRA/FOAMEX
V-SS1	4	SHELF SUPPORT

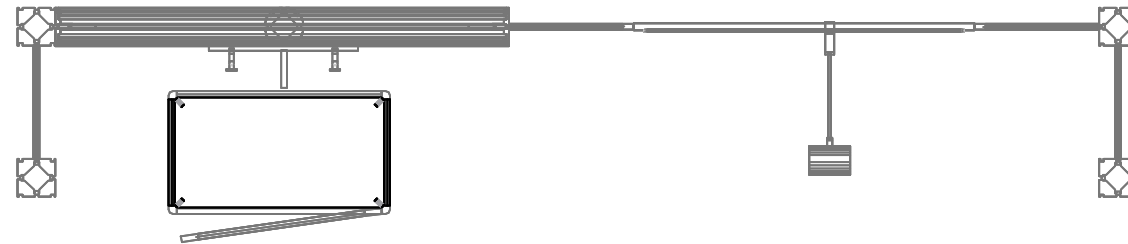

1. Redesign of this exhibit without approval by manufacturer may result in dangerous and unsafe structures. Manufacturer disclaims any responsibility for redesigned exhibits it does not approve in writing.

2. Parts and components such as panels and extrusions are manufactured to metric sizing. Where ever possible sizes have been noted in feet and inches as well as in metric. Below is the imperial to metric sizing table as reference. *Nominal* refers to approximate size.

2400mm = (94 1/2")	Phone Line / Fax
2100mm = (82 5/8")	Internet connection
1800mm = (70 7/8")	Outlet
1500mm = (59")	Main Drop (point of distrution)
1200mm = (47 1/4")	
900mm = (35 1/2")	
600mm = (23 5/8")	
300mm = (11 7/8")	

--- Wire running under carpet

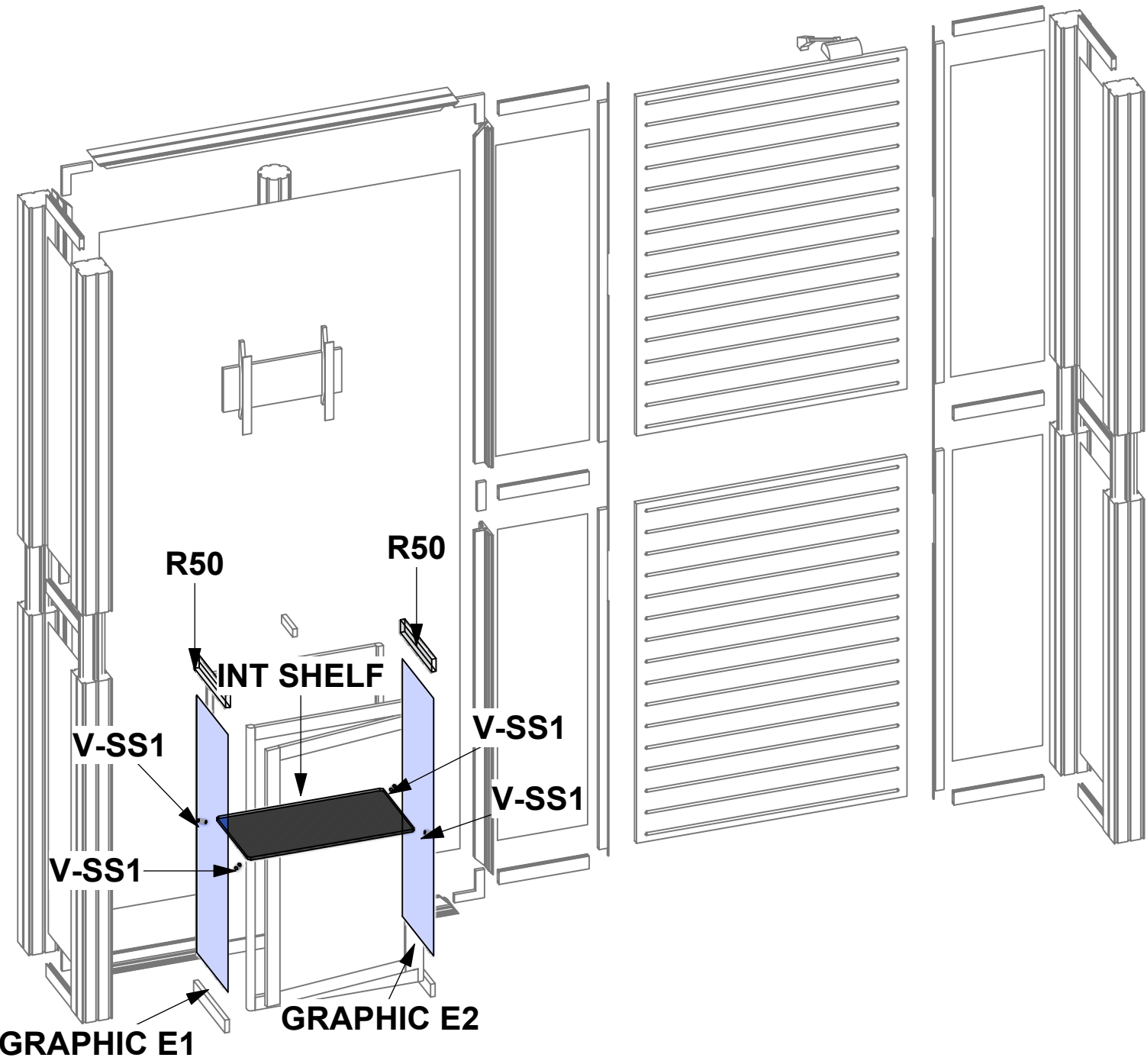
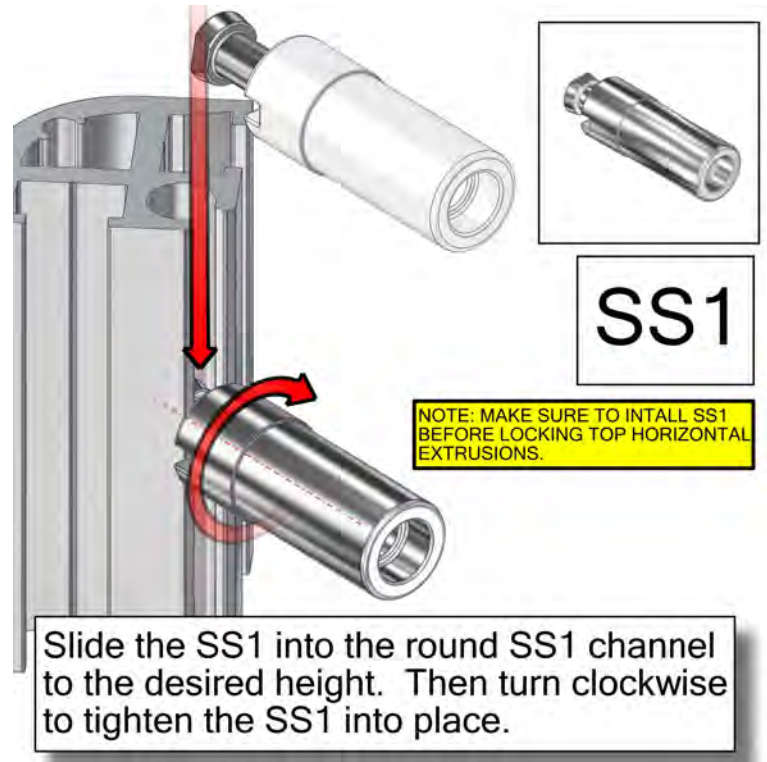

WARNING!
Locks should ONLY be turned a half (or quarter) turn so as not to STRIP the locks by over torqueing them

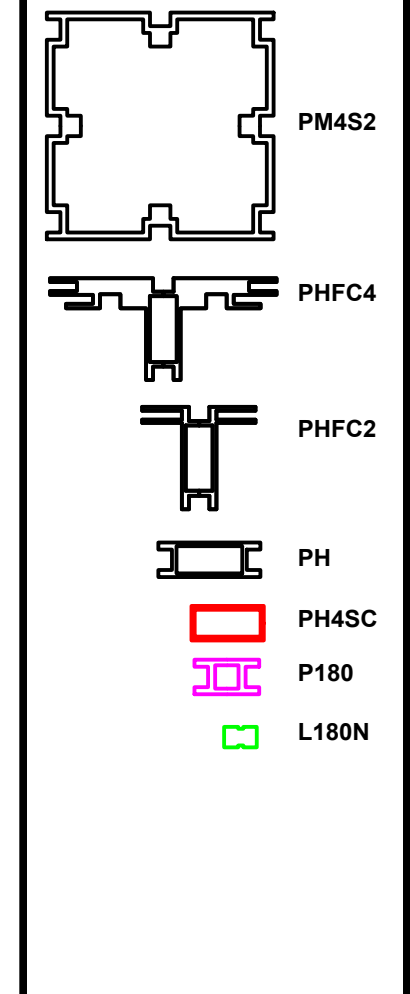
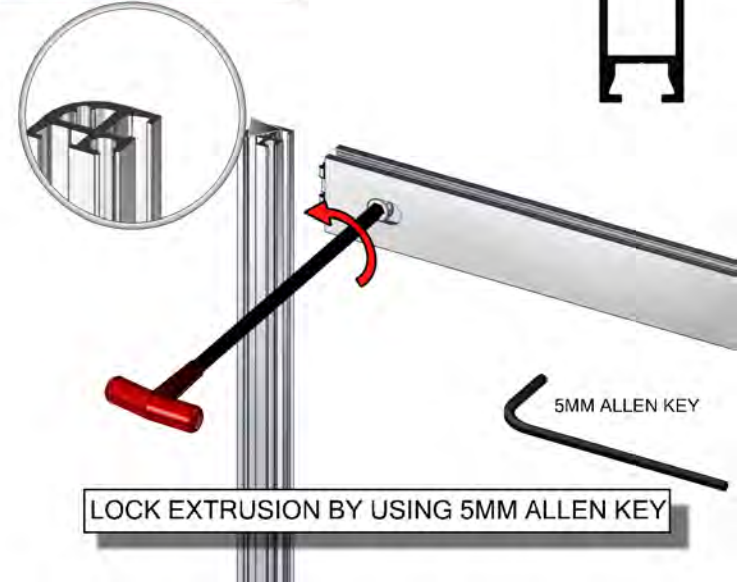

HYBRID PRO RENTAL KIT

Title: SET-UP INSTRUCTIONS

Code	#	Description
V-CW-CT-01	1	384MM X 646MM (15 1/8" X 25 7/16") HYBRID RECTANGLE TOP

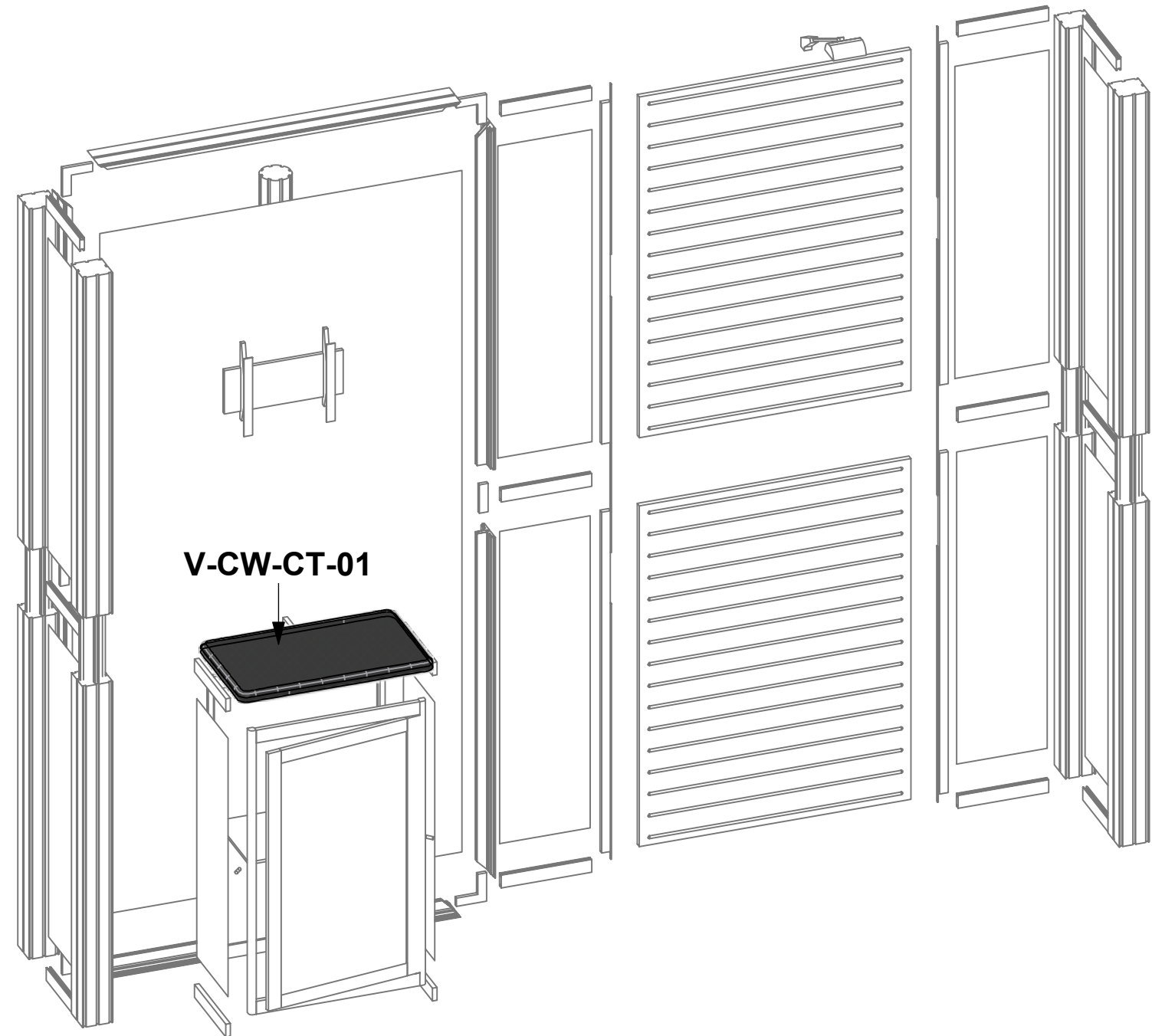
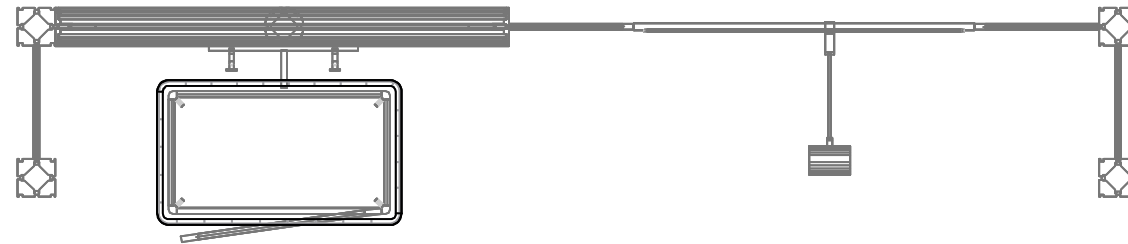

1. Redesign of this exhibit without approval by manufacturer may result in dangerous and unsafe structures. Manufacturer disclaims any responsibility for redesigned exhibits it does not approve in writing.

2. Parts and components such as panels and extrusions are manufactured to metric sizing. Where ever possible sizes have been noted in feet and inches as well as in metric. Below is the imperial to metric sizing table as reference. "Nominal" refers to approximate size.

2400mm = (94 1/2")	☐ Phone Line / Fax
2100mm = (82 5/8")	☐ Internet connection
1800mm = (70 7/8")	☐ Outlet
1500mm = (59")	☐ Main Drop (point of distrution)
1200mm = (47 1/4")	
900mm = (35 1/2")	
600mm = (23 5/8")	
300mm = (11 7/8")	

--- Wire running under carpet

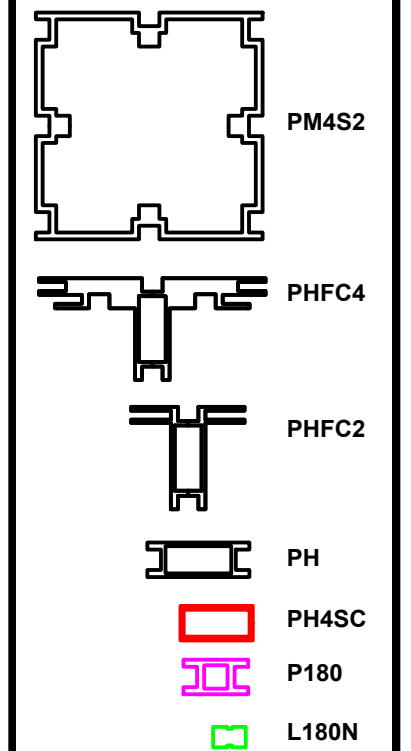

HYBRID PRO RENTAL KIT

Title: SET-UP INSTRUCTIONS

PACKING INSTRUCTIONS



1
 (1) MEDIUM MONITOR BRACKET
 (1) STEAMER, HARDWARE BOX



2
 (1) V-CW-CT-01, (1) INTERNAL SHELF

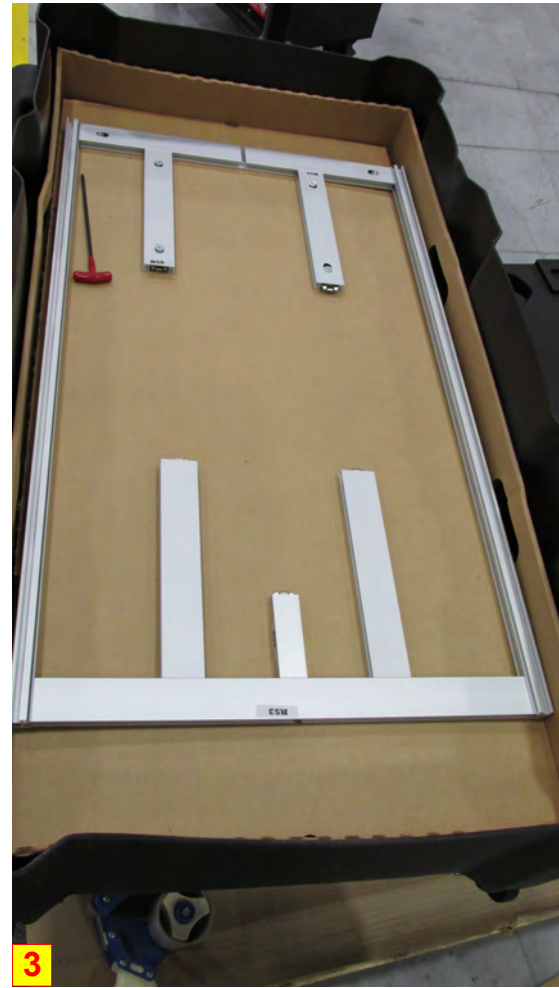

3
 (1) R53, (4) R50, (1) R48



4
 (1) R52



5
 (2) LED LIGHTS

HARDWARE BOX



CASE # 1

LEGEND		GREY FOAM FOLDED TO FILL EMPTY SPACES OR USED AS PROTECTION
		1/8" CARDBOARD SPACER (PUT IN BETWEEN EVERY PANEL)
		DIVIDER
		1/4" WHITE FOAM (USED AS PROTECTION DOOR PANELS W/ LOCKS)





(12) R18, (4) R13,(1) R14
 (4) L180N-900,(2) R9,(2) R11



(2) R12

CASE # 2

LEGEND		GREY FOAM FOLDED TO FILL EMPTY SPACES OR USED AS PROTECTION
		1/8" CARDBOARD SPACER (PUT IN BETWEEN EVERY PANEL)
		DIVIDER
		1/4" WHITE FOAM (USED AS PROTECTION DOOR PANELS W/ LOCKS)





(1) R47





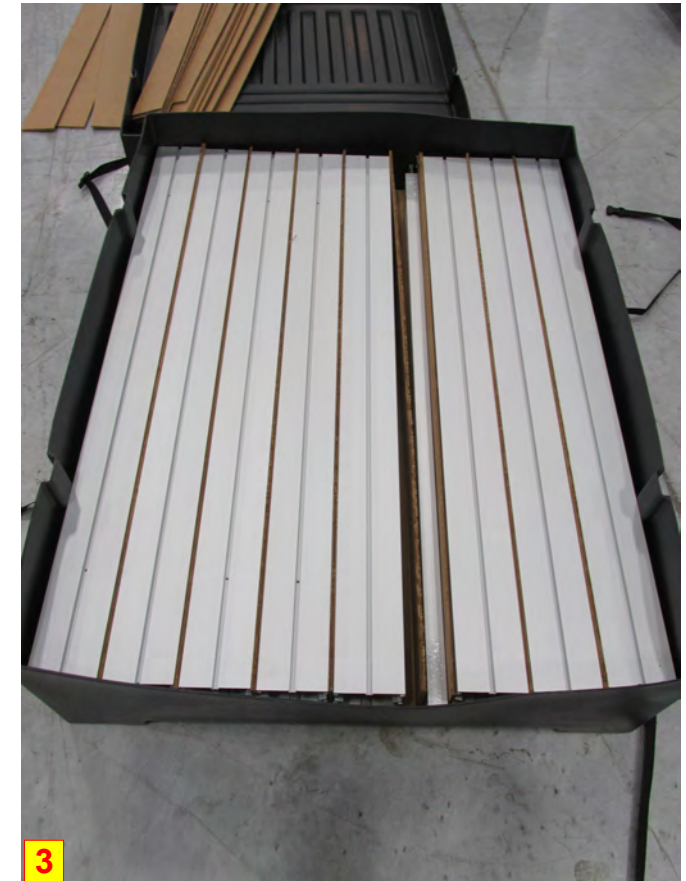

(1) R47



(8) R15, (4) P180-1200

CASE # 3

LEGEND		GREY FOAM FOLDED TO FILL EMPTY SPACES OR USED AS PROTECTION
		1/8" CARDBOARD SPACER (PUT IN BETWEEN EVERY PANEL)
		DIVIDER
		1/4" WHITE FOAM (USED AS PROTECTION DOOR PANELS W/ LOCKS)

